



Office of Broadband & Geospatial Initiatives (OBGI)

The New Mexico Broadband Program

Broadband for Businesses Study

Version 2.0, June 30, 2017

Prepared for:
The New Mexico Broadband Program
Office of Broadband & Geospatial Initiatives
NM Department of Information Technology
www.doit.state.nm.us/broadband

Prepared by:
CTC Technology & Energy
Kensington, Maryland
<http://www.ctcnet.us/>

**The New Mexico Broadband Program
Broadband for Businesses Study**

Version 2.0, June 30, 2017

Table of Contents

Table of Contents.....	i
List of Tables	vi
List of Figures.....	vii
Executive Summary	1
Overview	1
Research Process	1
Analysis of Approaches for Improving Connectivity in Underserved Areas.....	2
High-Level Estimate of Cost to Connect Underserved Businesses.....	3
Recommendations for Implementation	3
Establish Permanent Funding for the State Broadband Office.....	4
Consider Public Funding.....	4
Encourage Joint Purchasing	5
Leverage Service to Community Anchor Institutions	5
Consider a “Dig-Once” Policy to Coordinate Excavation Projects and Decrease Broadband Deployment Costs	5
Standardize and Simplify the Process for Accessing the Public Right-of-Way (PROW).....	5
Promote a Collaborative Planning and Implementation Framework.....	6
Chapter 1: Overview of Current Business Broadband Services in New Mexico	7
Most Businesses in the State Have Access to Cable or Fiber Service.....	7
Underserved Areas Identified During Gap Analysis.....	14
Commercial Corridors and Residential Developments.....	15
Outlying Areas of Large and Medium-Sized Cities.....	16
Smaller Cities Mostly or Entirely Unserved by Fiber or Cable	17
Coverage Discrepancies in the New Mexico Broadband Map.....	18
Underserved Businesses by County.....	18
Chapter 2: Technical Approaches for Broadband Expansion	21
Fiber Network Expansion	21
Architecture	21
Network Expansion Costs.....	23
Cable Network Expansion	25

Architecture	25
Network Expansion Costs.....	26
DSL Network Upgrades	26
Architecture	26
Upgrade Costs	27
Fixed Wireless Network Connectivity	28
Architecture	28
Network Expansion Costs.....	28
Mobile Broadband Connectivity	29
Chapter 3: Recommended Technical Solutions for Underserved Areas	30
Small Commercial Corridors and Residential Developments	30
Network Expansion Description.....	31
Outlying Areas of Large and Medium-Sized Cities.....	34
Network Expansion and Upgrades.....	35
Smaller Cities Mostly or Entirely Unserved by Fiber or Cable	35
Network Expansion and Upgrades.....	37
Network Expansion Cost Estimates: Underserved Businesses in Bernalillo County	38
Network Expansion Cost Estimates: Underserved Businesses in Socorro County.....	43
Statewide Broadband Network Expansion Cost Estimates to Underserved Businesses.....	44
Chapter 4: Analysis of Databases, Business Survey and Provider Discussions	46
Infogroup Database Review.....	46
Review of Survey Data	46
Discussions with Service Providers	46
Briefing to Service Providers	47
Common Themes	47
Chapter 5: Recommended Implementation Strategies	49
Establish Permanent Funding for the State Broadband Office	49
Consider Public Funding for Broadband Infrastructure.....	50
Use Joint Purchasing Strategies to Reduce Businesses’ Broadband Costs.....	51
Description of the Joint Purchasing Model.....	51
Benefits of the Joint Purchasing Model	51

Leverage Purchasing Power of Community Anchor Institutions	52
Consider “Dig-Once” Policies to Coordinate Excavation Projects and Decrease Broadband Deployment Costs	52
Standardize and Simplify the Process for Accessing the PROW	53
Promote a Collaborative Planning and Implementation Framework.....	53
Chapter 6: Case Studies—Analysis of Statewide Projects for Business Broadband	55
Case Study: Culver City, California	55
Background	55
Planning.....	55
Execution.....	56
Case Study: Vallejo, California	57
Background	57
Planning.....	57
Case Study: Westminster, Maryland	57
Background	58
Planning.....	58
Execution.....	58
Case Study: Connecticut	59
Background	59
Comparison with Recommended Strategies for the BB4B Study.....	60
Appendix A: Summary of Stakeholder Engagement and Methodology	61
Appendix B: Broadband Service Provider Outreach Presentation.....	62
Appendix C: Summary of Data Sources Collected	63
Map Datasets	63
Connect America Fund (CAF)	63
Appendix D: BB4B Survey to Businesses	65
Appendix E: Field Survey Findings	66
General Findings	66
Albuquerque	66
Bernalillo	69
Downtown Santa Fe.....	69

Old Santa Fe Trail Area.....	72
Pojoaque, Española, and Cundiyo	73
Rio Rancho	74
Reservation Areas	76
Google Earth Surveys	78
Appendix F: Glossary of Terms	79
Appendix G: Abbreviations and Acronyms.....	81
End Notes.....	82

List of Tables

Table 1: Percentage of Underserved Businesses by County	19
Table 2: Summary of Commercial Corridor Expansion Cost – Typical 10-Business Area.....	33
Table 3: Estimated Costs for Network Expansion to Underserved Businesses in Bernalillo County	42
Table 4: Broadband Upgrades Cost to Underserved Business by County.....	45

List of Figures

Figure 1: Capacity of Wired and Wireless Technologies	3
Figure 2: Underserved Businesses in the State with Only DSL Service	8
Figure 3: Underserved Businesses in the Albuquerque Area with Only DSL Service	9
Figure 4: Underserved Businesses in the Santa Fe Area with only DSL Service.....	10
Figure 5: Underserved Businesses in the Las Cruces Area with Only DSL Service	10
Figure 6: Underserved Businesses in the Rio Rancho Area with Only DSL Service	11
Figure 7: Underserved Businesses in the Farmington Area with Only DSL Service	11
Figure 8: Underserved Businesses in the Clovis Area with Only DSL Service.....	12
Figure 9: Underserved Businesses in the Alamogordo Area with Only DSL Service	12
Figure 10: Underserved Businesses in the Lovington Area with Only DSL Service	13
Figure 11: Areas with Only DSL That Are Not Eligible for CAF.....	14
Figure 12: Broadband Coverage in Area Around the Mall Along Uptown Loop Rd NE in Albuquerque	15
Figure 13: Broadband Coverage in Industrial Area Along Industrial Avenue NE in Albuquerque ...	15
Figure 14: Broadband Coverage at Sample Apartment Complex Along Montano Street in Santa Fe	16
Figure 15: Broadband Coverage and Stores Along Broadway Boulevard SE in Albuquerque	17
Figure 16: Broadband Coverage Along West Main Street in Farmington.....	17
Figure 17: Broadband Coverage in Socorro.....	18
Figure 18: Population Density by County Versus Percentage Underserved Businesses.....	20
Figure 19: High-Level FTTP Architecture	22
Figure 20: FTTP PON Network Architecture.....	23
Figure 21: HFC Network Architecture	25
Figure 22: DSL Network Architecture.....	27
Figure 23: Underserved Area Fed by Fiber (Pink) to a New Node with New Service Drops (Yellow)	31
Figure 24: Aerial Building Entry	32
Figure 25: Underground Building Entry.....	32
Figure 26: Underserved Businesses in the Albuquerque Area (with Only DSL Service)	33
Figure 27: Underserved Businesses in the Santa Fe Area (with Only DSL Service).....	34

Figure 28: Underserved Areas in Small Cities That Are Not Near Existing Cable or Fiber 36

Figure 29: DSL or CATV Network with Fiber Extended to a Node Close to the Customer Premises to Enhance Network Capacity..... 37

Figure 30: GPON Fiber Network with a Buried Service Drop 37

Figure 31: Underserved Business Locations in Bernalillo County 38

Figure 32: Underserved Businesses in Albuquerque (Enlarged to Illustrate Built-Up Area)..... 39

Figure 33: Cable (Brown) and Fiber (Pink) Availability Near Underserved Business Locations in Bernalillo County 40

Figure 34: Underserved Businesses in Remote Areas 41

Figure 35: Underserved Business Locations in Socorro County 43

Figure 36: Broadway Boulevard, South of Route 500 67

Figure 37: Telephone Lines on Broadway Boulevard 68

Figure 38: Broadway Boulevard 68

Figure 39: Downtown Santa Fe – Assorted Cables to Rooftop 69

Figure 40: Downtown Santa Fe – Ad Hoc Telecommunications Cabling Hanging from Building to Building 70

Figure 41: Downtown Santa Fe – Curb Providing Opportunity for Microtrench Construction 71

Figure 42: Microtrench Cross-Section View 71

Figure 43: Old Santa Fe Trail – Poles with Ample Space for Broadband Attachment..... 72

Figure 44: Old Santa Fe Trail – Poles with Ample Space for Broadband Attachment..... 73

Figure 45: DSL-Only Region West of Rio Rancho..... 74

Figure 46: Rio Rancho Copper Telephone Lines..... 75

Figure 47: Rio Rancho Copper Telephone Lines..... 75

Figure 48: Rio Rancho Buried Telephone Infrastructure..... 76

Figure 49: Reservation Area CATV Infrastructure 77

Figure 50: Reservation Area Copper Telephone Infrastructure 77

Executive Summary

Overview

The Department of Information Technology (DoIT) Office of Broadband & Geospatial Initiatives (OBGI) began in 2016, as an expansion of the successful New Mexico Broadband Program (NMBBP). The NMBBP grew out of a federal grant received in 2010, which funded the State Broadband Initiative.

The OBGI coordinates broadband and geospatial activities within New Mexico while collaborating with State, local, federal, tribal, and private entities to leverage returns on investments, economies of scale, and sustainability. The Office also consolidates State resources to help the greater good and encourages internet service provider (ISP) transparency through State-owned resources (e.g., <https://nmbbmapping.org/mapping/>).

This document is the result of the NMBBP's request for CTC Technology and Energy (CTC)¹ to create an actionable roadmap that provides recommendations for improving access to affordable and reliable broadband services for businesses in support of economic development.

CTC prepared a preliminary report in late 2016 discussing tools and recommendations for both State and local government policymakers regarding expanding gigabit broadband facilities to businesses.²

This report elaborates on those insights by evaluating the current broadband infrastructure available at business locations in the State and develops a range of strategies for improving the broadband services to underserved areas (see Chapter 1). Further, it identifies the range of State and local entities that would likely be involved in the implementation of new broadband facilities.

Research Process

To assess the current availability of broadband services for New Mexico businesses, CTC made use of several existing datasets, including current broadband coverage maps from the NMBB project³ and maps from the Federal Communications Commission (FCC) showing census blocks that are expected to receive support for broadband expansion through the FCC's Connect America Fund (CAF).⁴ Using these data sources, CTC created maps showing "underserved" areas where businesses lack adequate wired broadband services and are not expected to see increased broadband deployment from federal CAF funding.

CTC combined this information with a dataset of geocoded business listings obtained by the State from Infogroup, a data services provider. CTC also engaged with regional carriers to verify the accuracy of these underserved areas, to integrate the carriers' coverage data where possible and to understand technical and business challenges that may hinder expansion in these areas.

Additionally, CTC performed desk and field surveys to assess the current state of broadband infrastructure and the cost of implementing or expanding broadband infrastructure in underserved areas.

The analysis included examining the availability of the three most common technologies used to deliver "last-mile" broadband data services (i.e., the connection from a provider's network to the user's premises) to businesses: fiber-to-the-premises (FTTP), digital subscriber line (DSL), and hybrid fiber-coaxial (HFC) cable. CTC found that approximately 75 percent of the businesses surveyed in the state had access to a

cable or fiber-based broadband service, which is superior to DSL. Just under 12 percent of the rest of the businesses had access to only a DSL service, which is generally inadequate for most business needs. Ultimately, approximately 14,600 of the 140,000 businesses fell into those areas that are considered “underserved” for the purposes of this report.

CTC further classified the underserved areas into three broad categories:

- Commercial corridors and residential developments
- Outlying areas of large and medium-sized cities
- Smaller cities mostly or entirely unserved by fiber or cable

CTC also looked at the extent of the lack of adequate broadband in counties within the State. The overall trend that CTC noted was that counties with lower population density (less than six persons per square mile) have a higher percentage of underserved businesses—that is, the businesses in most of these counties (those with at least 30 underserved business locations) are underserved by over 35 percent.

Analysis of Approaches for Improving Connectivity in Underserved Areas

Over the past few decades, extending the fiber network closer to the customer has become an essential part of any communications technology strategy. Thereafter, the quality and speed of a broadband connection varies based on the capacity and limitations of the last-mile technology used, if any, between the fiber and the customer. To provide the optimum solution to improve connectivity to an underserved business in a particular type of area, various factors come into play, such as the needs of the business (bandwidth and scalability), proximity to existing broadband infrastructure, the additional underground construction required, access to aerial infrastructure, and other costs like associated upgrades to electronics.

CTC performed an analysis based on field surveys, the mapping of underserved areas, feedback from service providers, and typical industry practices and costs. CTC found that costs to serve the businesses in underserved commercial corridors will typically range from about \$1,000 to more than \$5,000 with a likely statewide average of approximately \$2,000, if the service expansion is performed by the providers already serving the adjacent areas and is done as part of a bulk expansion, and not individually.

CTC found that the cost of expansion of broadband into larger underserved areas, mostly surrounding the cities already served, depends critically on the specific environment, but that most can be served either by enhancement of the existing copper service or, at more cost, with expansion of cable broadband or fiber service. As an example, the underserved area at the southeastern end of Albuquerque can be connected with enhanced DSL service for approximately \$3,000 per potential service address (also known as a “passing”) or cable broadband for \$5,000 per passing. The enhanced DSL service would provide approximately 50 Mbps, and the cable broadband service a few hundred Mbps with capability to scale to higher speeds without substantial new construction.

Figure 1 below illustrates the capacity of DSL, cable, and fiber broadband services, as well as other wired and wireless technologies.

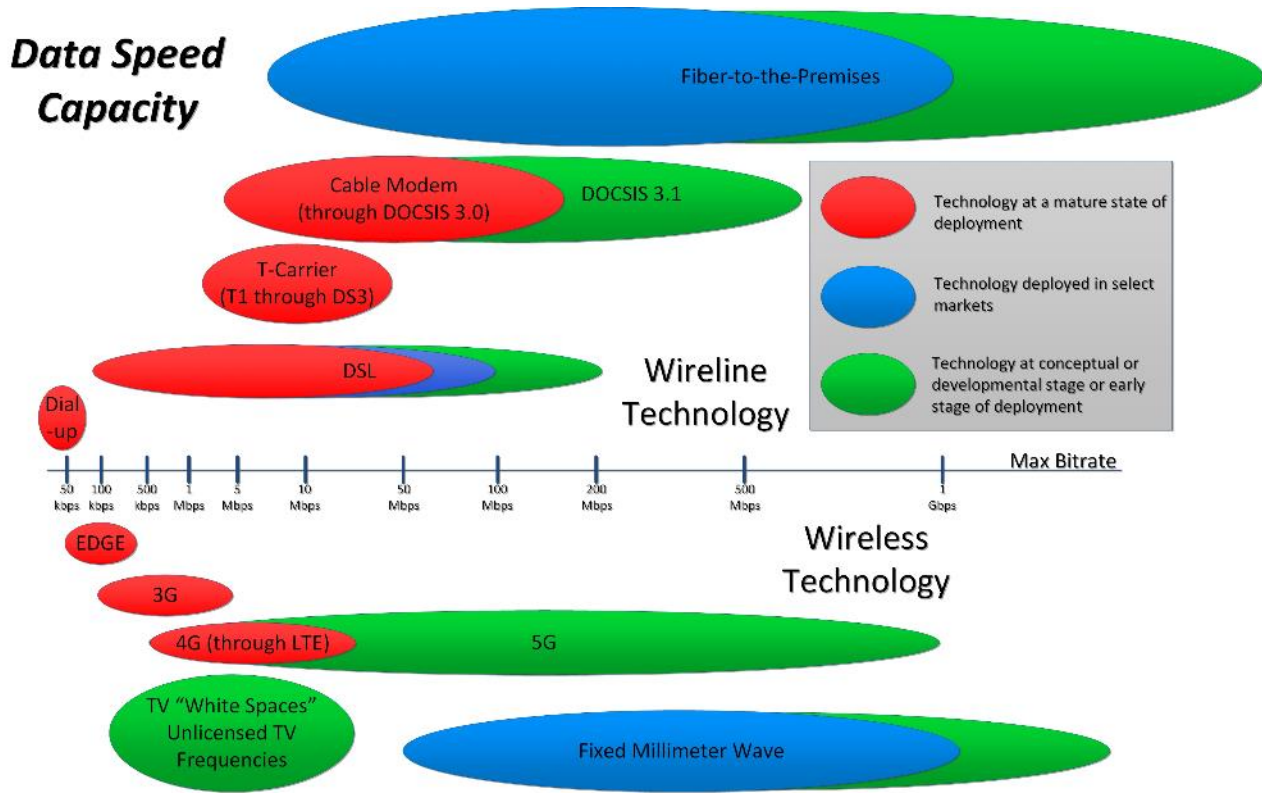

Figure 1: Capacity of Wired and Wireless Technologies

For cities and towns that are mostly or entirely underserved, CTC analyzed scenarios where cable TV systems activated for television and not broadband, were upgraded to broadband service, and where new networks are built. If cable TV service exists, the cost of a city-scale cable system upgrade to cable broadband is, on average, \$500 per passing.

If there is no cable TV infrastructure, the cost of enhancing broadband depends on the local environment (e.g., construction cost, the size of the service area, and proximity to existing infrastructure) and it is worth considering a wide range of options, including advanced DSL and wireless services.

High-Level Estimate of Cost to Connect Underserved Businesses

Using the above framework (which is described in detail in Chapter 3), CTC developed high-level cost estimates for expanding broadband in the State. CTC identified the different type of underserved areas in each county and extrapolated the costs to connect businesses in each area.

CTC estimate that the high-level cost for extending service to 14,253 of the underserved businesses would be approximately \$42 million. Approximately 125 of these locations appeared to be suited for the low-end option of upgrading cable TV but further field surveys are needed to ascertain the presence of cable TV. Another 340 locations were considered too remote for wired expansion and are not included in the estimate because an entirely new network or wireless options would be a better fit.

Recommendations for Implementation

Without expansion of broadband access, economic development and business growth are likely to decline. This is especially true for rural areas, where broadband may be the key to community sustainability.

Full public or private investment would be the most direct approach to expanding broadband infrastructure to serve businesses in the State. But absent that single-source funding, there exist a range of potentially lower-cost approaches—focused on strategic planning and collaboration—that may help the State to incrementally increase and improve the availability of broadband to currently unserved businesses.

Establish Permanent Funding for the State Broadband Office

It is widely recognized among broadband planners and economic development professionals that state offices of broadband planning are an important differentiator for rural broadband expansion. Even in the absence of state funding to build new broadband networks, a broadband office enables the state to coordinate and plan among public and private entities, including for purposes of taking advantage of new federal grant opportunities.

For these reasons—and to build on New Mexico’s successful investment to date—the State should consider legislation that would provide ongoing funding for the Office of Broadband & Geospatial Initiatives (OBGI). Such stable funding would allow the office to continue its efforts toward broadband opportunity—including through community outreach and mapping—without the frequent uncertainty regarding future appropriations.

Secure funding for OBGI would also support the office’s important strategic role—perhaps best illustrated by its potential to engage with the FCC’s Connect America Fund program. If authorized and funded, the OBGI could be a critically important conduit to work with private carriers to determine their CAF buildout and service plans, and then to verify that they are delivering what they promised the federal government.

Similarly, over time, OBGI could play a critically important role in encouraging providers to apply for federal funds and, where offered, to accept the funding in the best interest of the State of New Mexico. Through OBGI, the State would be in a position to work with companies such as Windstream and Plateau to advocate for New Mexico’s interests with regard to federal funding in Washington. At the same time, OBGI would be in a unique position to work with other State agencies and local communities to identify ways to improve the economics for companies like Windstream such that those companies would be willing to accept federal funds and invest accordingly in New Mexico. (See Chapter 5 for more details.)

Consider Public Funding

In large parts of the United States, telecommunications and broadband deployment are not commercially viable absent some significant form of public funding. For this reason, the federal government and many states have long supported funds that subsidize operations in high cost areas where the private sector cannot make a return absent the subsidy. Current federal programs, most significantly the Connect America Fund, are designed to provide an operating subsidy to telecommunications companies for such high cost areas, but this program prioritizes residential service—not services to businesses. Regardless of the mechanism, CTC note here that some form of subsidy is likely to be required now or in the future to address the needs of New Mexico small businesses for adequate broadband.

Absent public funding, there do exist a range of mechanisms that the state and others can use to create an environment that is maximized (though not, of course, guaranteed) to attract investment from providers into the underserved areas. These mechanisms, which represent best practices and will improve conditions for private investment, include the following.

Encourage Joint Purchasing

New Mexico businesses can be encouraged to aggregate their buying power to improve the attractiveness to private providers of serving them with broadband. Using this strategy, multiple businesses in proximity to each other would produce a simple Request for Proposal (RFP) to solicit and contract for business broadband services. The businesses would cooperate to develop the RFP and select the vendor.

The benefits of pursuing this model include:

- Lower per-unit pricing and reduced non-recurring charges
- Increased private sector investment and better services in the immediate area

The State can pursue different levels of involvement—from advocacy and education (such as providing draft RFPs, explaining the process in written material and presentations) to directly assisting in the processes and potentially matching funds. Ideally, an RFP should not pose a paperwork burden for providers and allow them flexibility with regard to the service model offered.

Leverage Service to Community Anchor Institutions

In a similar vein, the buying power of the public sector can also be utilized to incent new deployment. CTC recommends that the State incentivize broadband expansion through its procurement processes for broadband to public institutions. Community anchor institutions (CAIs) such as schools, libraries and healthcare institutions frequently require fiber connectivity. Therefore, the service provider connecting the CAI can offer broadband more cost-effectively to residents and businesses in the surrounding area. One approach would be for the public institution to offer more points in a bid scoring process to providers who can demonstrate how selecting them can lead to improved, cost-effective service to surrounding businesses and residents.

Consider a “Dig-Once” Policy to Coordinate Excavation Projects and Decrease Broadband Deployment Costs

CTC recommends that the State identify planned excavation projects and create a public database of projects, project descriptions, project managers and construction dates in order that DoIT OBG and broadband deployers can identify opportunities for broadband deployment. This can be part of a “Dig-Once” policy, as encouraged in the National Broadband Plan, that can enable service providers to more cost-effectively construct fiber optics and other broadband infrastructure at reduced cost while a trench is open or a road is under construction.

Standardize and Simplify the Process for Accessing the Public Right-of-Way (PROW)

The processes and fees associated with permitting and accessing the PROW may have aspects that hamper the rate of broadband expansion in the State. A provider typically obtains access from state, county, tribal agencies and other entities to access public or private land along their proposed construction routes. The PROW access approval process could be made into a State statute that could require agencies to follow State standards.

The economic development benefits of simplifying broadband expansion also need to be highlighted to all levels of the public, state and local leadership and relevant private businesses and non-profits. Building an outreach and awareness campaign that promotes the understanding of the central role of broadband in economic development, business growth, and rural sustainability will help in this regard.

Promote a Collaborative Planning and Implementation Framework

Greater collaboration with other state initiatives such as Broadband for Libraries (BB4L) and Broadband for Health (BB4H) and federal initiatives reduces redundancy and the costs associated with implementation strategies.

A mechanism to provide ongoing updates to the public on the progress made (particularly because of government initiatives) efforts is needed for furthering adoption. It would also improve transparency and foster competition amongst providers. As the underserved areas receive enhancements in services, the NMBB Program could continue to provide updates on new service availability information via the online mapping platform⁵ and notifications to business. Continued support to initiatives that disseminate information about service availability and infrastructure is important.

Chapter 1: Overview of Current Business Broadband Services in New Mexico

To effectively identify the businesses that may be underserved in broadband, the strategy was to review the State's broadband infrastructure mapping data, evaluate the results of a survey of businesses throughout the State, and meet with broadband service providers regarding options for closing the connectivity gap for businesses.

In its review of the mapping data, CTC created a methodology for identifying potential underserved areas by categorizing areas that did not have either fiber or cable broadband services. These areas are either unserved, served by dial-up lines, served by DSL, or served by wireless or satellite. While it is possible for a business to have currently sufficient quality connectivity with these services, these services are lower-speed and less scalable than fiber or cable broadband, and may have severe built-in limitations, such as a cap on the amount of data that can be used per month.

The identified underserved areas also by definition do not have competition between wireline services (i.e., broadband service delivered over a physical cable, as compared to wireless services), resulting in significantly less incentive to the incumbent providers to keep quality high or prices low.

Most Businesses in the State Have Access to Cable or Fiber Service

CTC conducted an analysis of the broadband availability across various cities and towns in the State based on the NMBBP broadband map.⁶ CTC focused on identifying the areas that had only DSL-based broadband service (and not cable- or fiber-based broadband service) and that would thus be classified as underserved.

CTC also analyzed these areas with data received on the businesses in the State.⁷ While these data are not comprehensive, they do provide a snapshot of the extent of gaps present in broadband services in the State.

Out of the 140,122 businesses that were included in the database, 16,411 businesses (11.71 percent) had access only to DSL services and are thus considered underserved. The database does not include some smaller businesses. Still, it appears that almost three-fourths of the businesses in the state are served by cable- or fiber-based service.

Figure 2 depicts these businesses across the state, which are spread out across different geographical and socio-economic regions.

Figure 3 and Figure 4 depict the underserved businesses (i.e., DSL only) in the Albuquerque and Santa Fe metropolitan areas.

Figures 5 to 10 depict the underserved businesses in some of the other larger cities in the State.

In all of these figures, underserved businesses are represented by green diamonds.

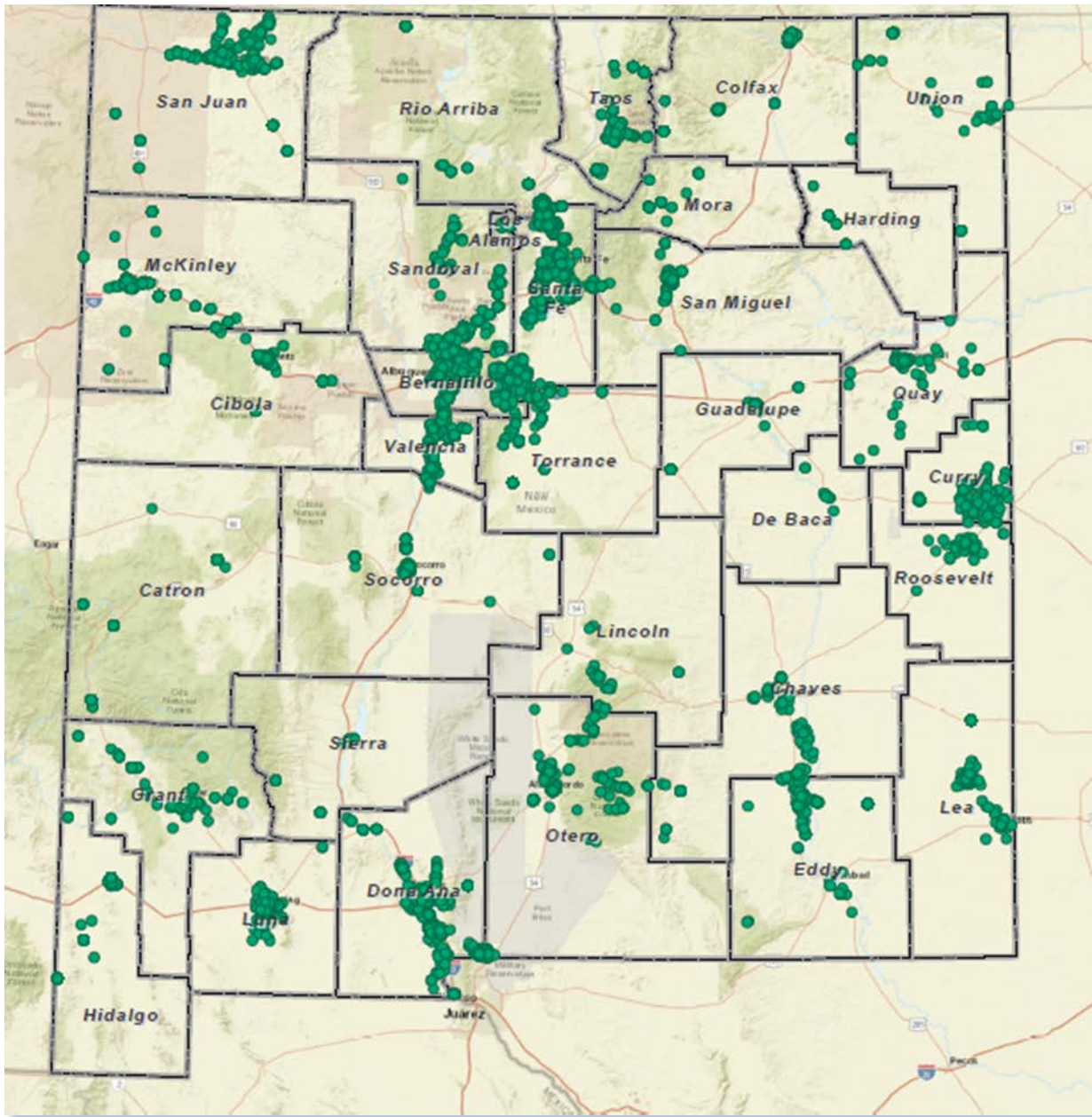

Figure 2: Underserved Businesses in the State with Only DSL Service

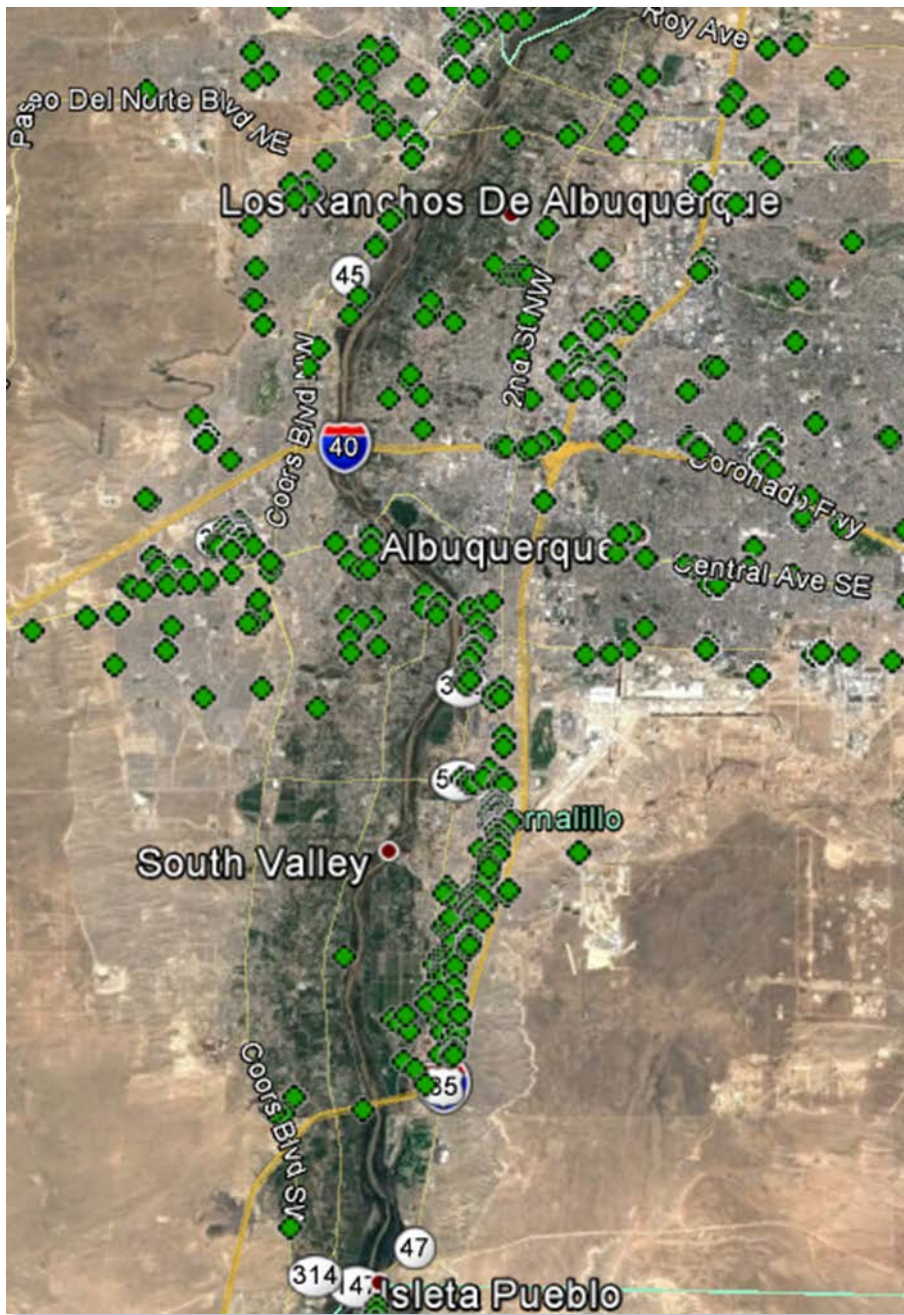

Figure 3: Underserved Businesses in the Albuquerque Area with Only DSL Service

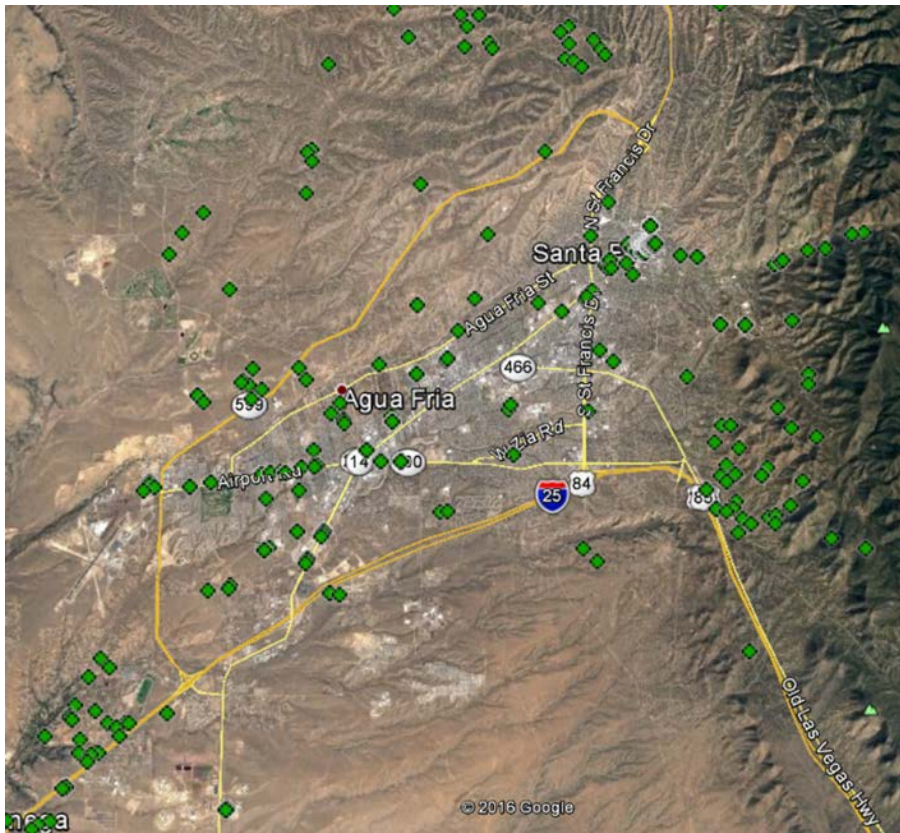

Figure 4: Underserved Businesses in the Santa Fe Area with only DSL Service

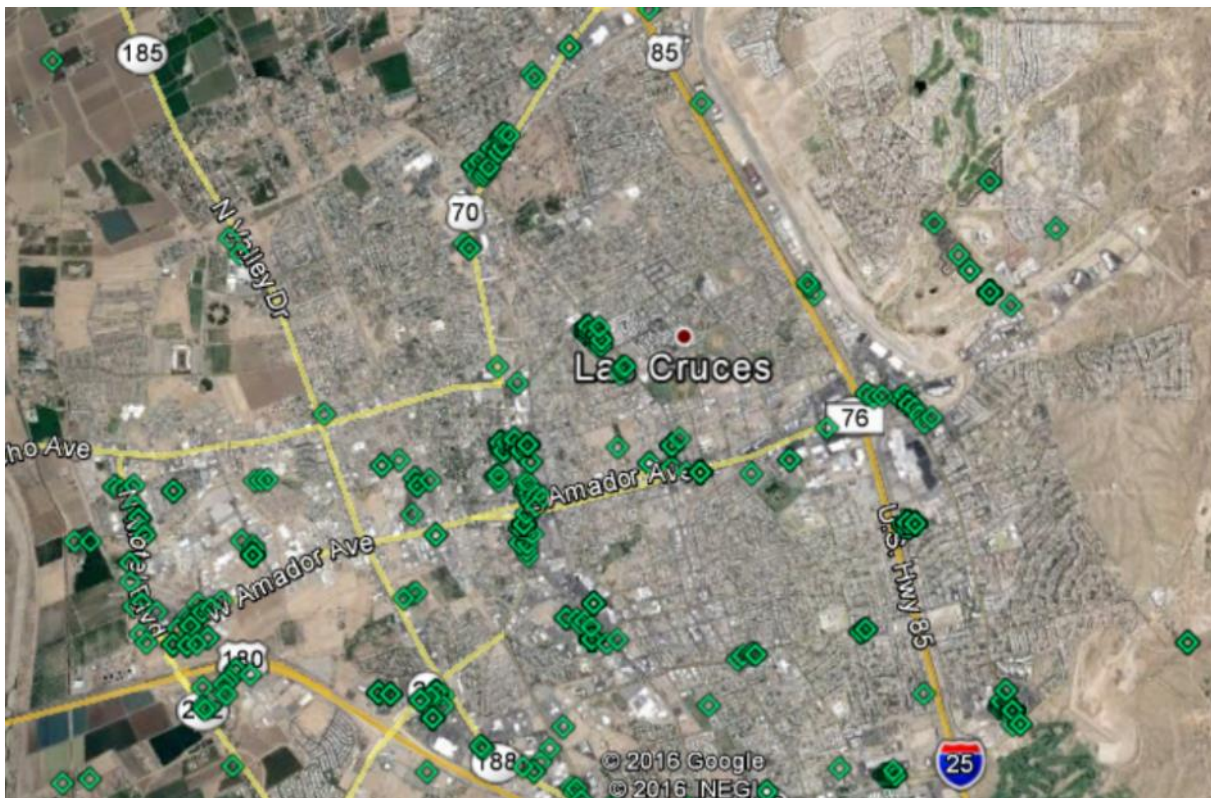

Figure 5: Underserved Businesses in the Las Cruces Area with Only DSL Service

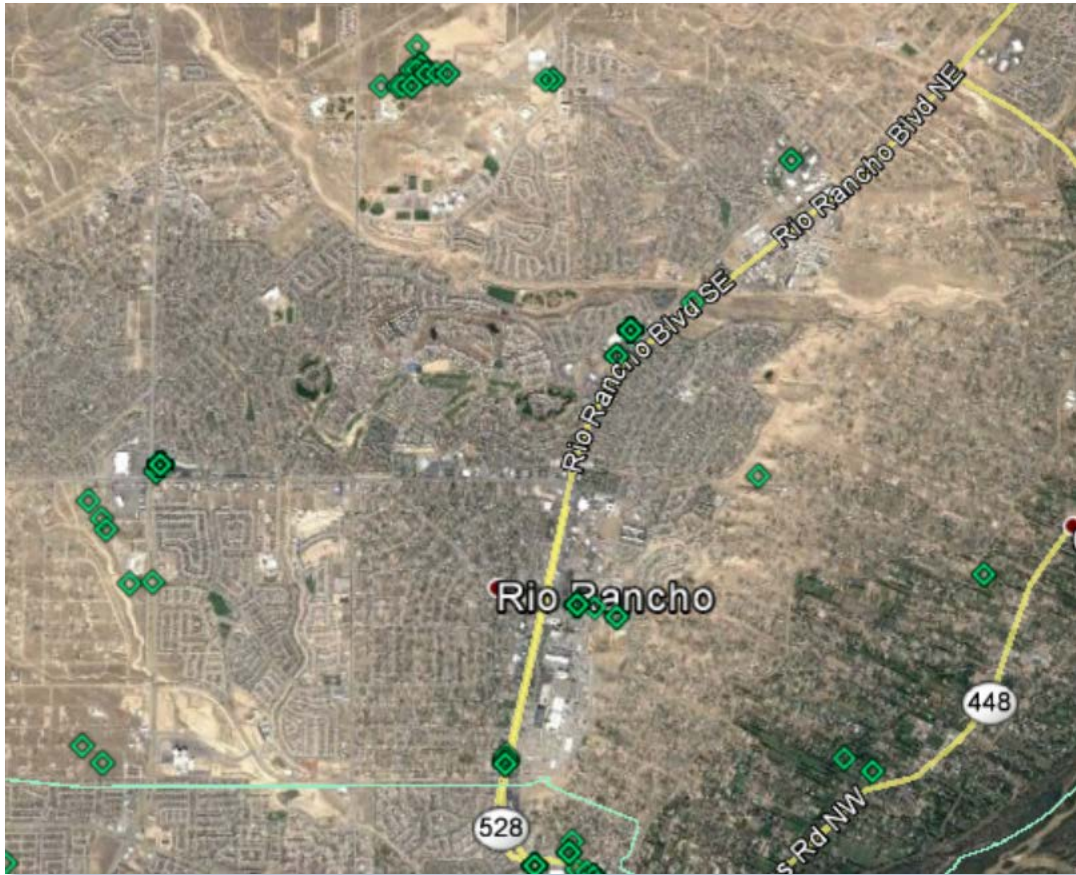

Figure 6: Underserved Businesses in the Rio Rancho Area with Only DSL Service



Figure 7: Underserved Businesses in the Farmington Area with Only DSL Service

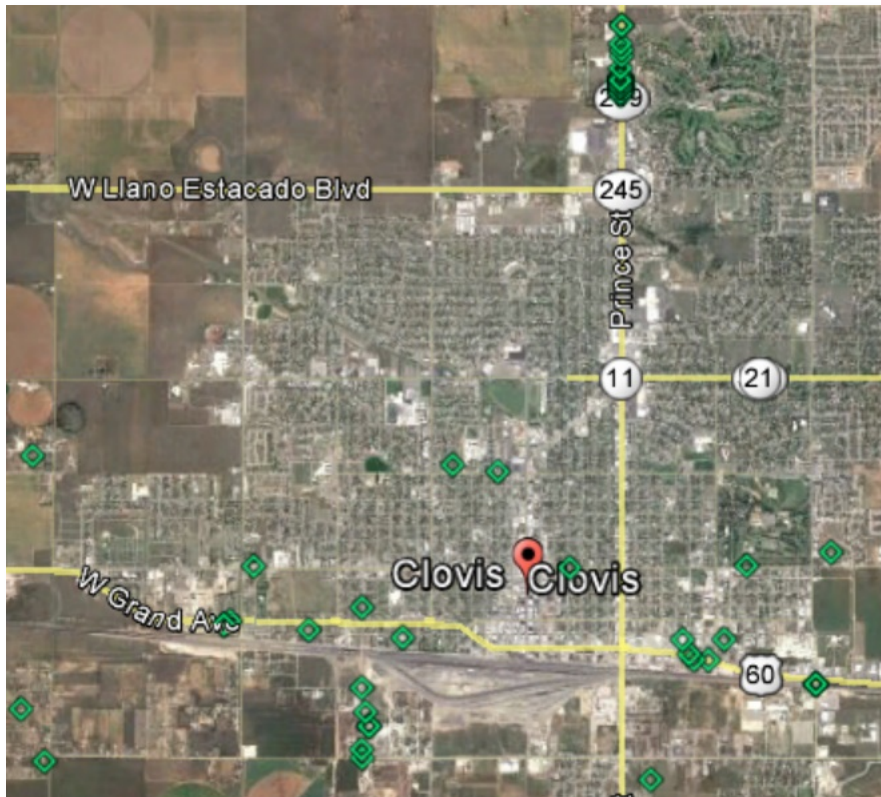

Figure 8: Underserved Businesses in the Clovis Area with Only DSL Service

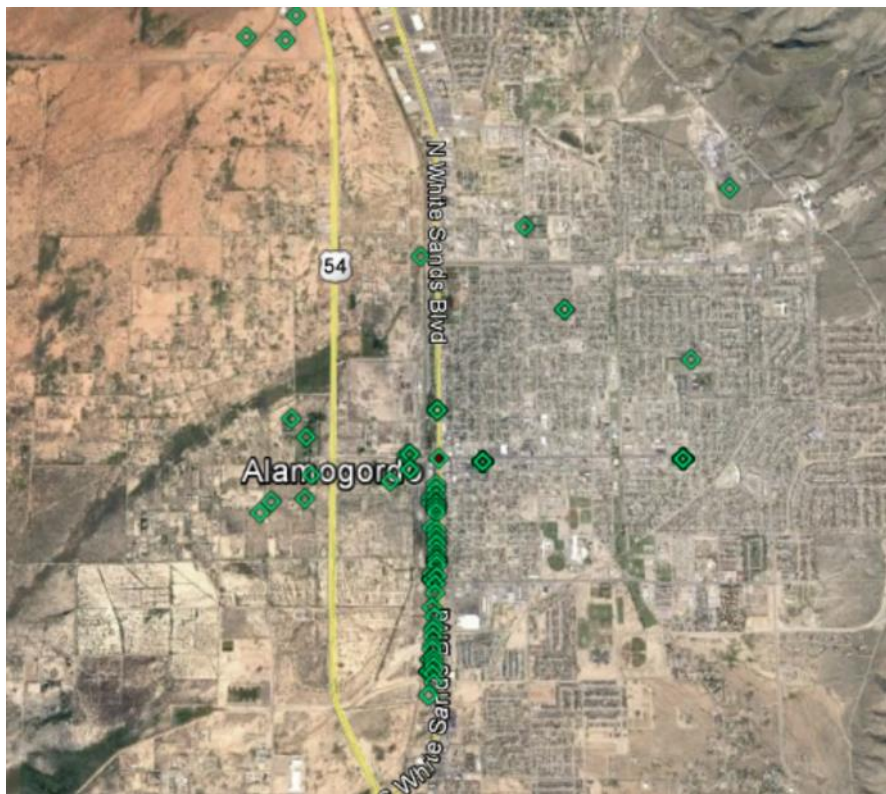

Figure 9: Underserved Businesses in the Alamogordo Area with Only DSL Service

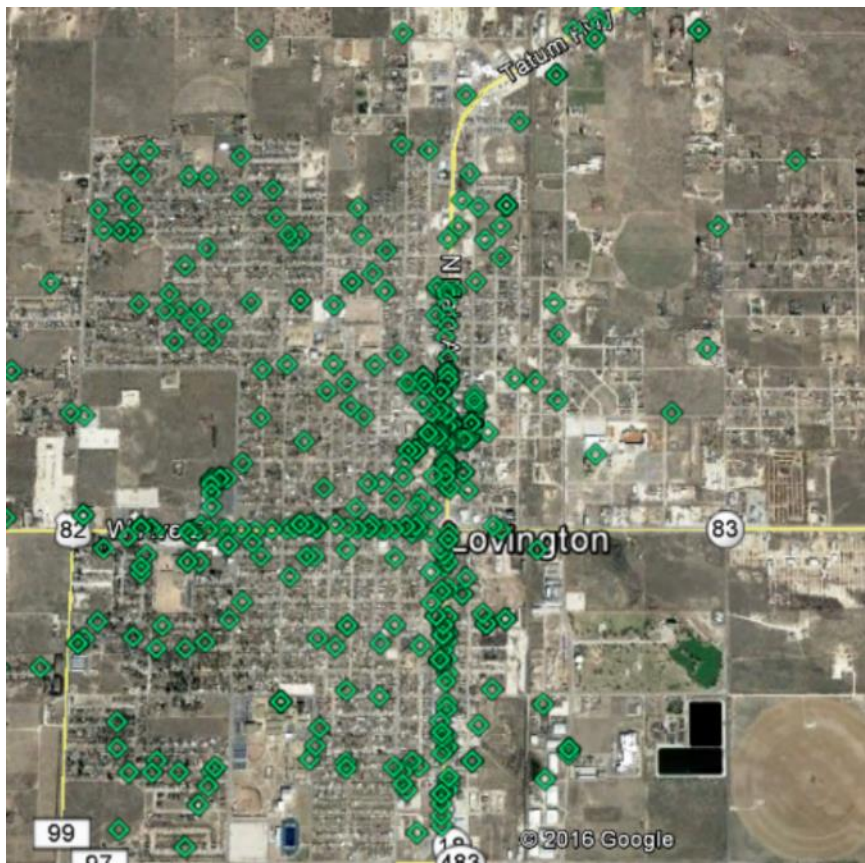

Figure 10: Underserved Businesses in the Lovington Area with Only DSL Service

A subset of these business locations (roughly 11 percent of the 16,411 businesses) are in areas where carriers are eligible for Connect America Funds (CAF) for serving residential customers. Although the CAF program does not fund the recipient carriers to serve businesses, CTC is optimistic that increased investment in these areas may have spillover effects for businesses; as the CAF recipients upgrade residential broadband infrastructure in the relevant areas, they may find it more cost-effective to extend better services to nearby businesses. Accordingly, CTC reduced its tally of underserved businesses to 14,592 out of 140,122 businesses statewide.

(The FCC's plan all along has been to reverse-auction CAF funding that was declined by price-cap carriers, so in those areas of New Mexico where Windstream declined funding, the funds will be available for other entities to bid on. That will presumably have potentially beneficial outcomes for businesses in those areas.)

These underserved areas (depicted in Figure 11) could be divided into three broad categories, as explained below:

- Commercial corridors and residential developments
- Outlying areas of large and medium-sized cities
- Smaller cities mostly or entirely unserved by fiber or cable

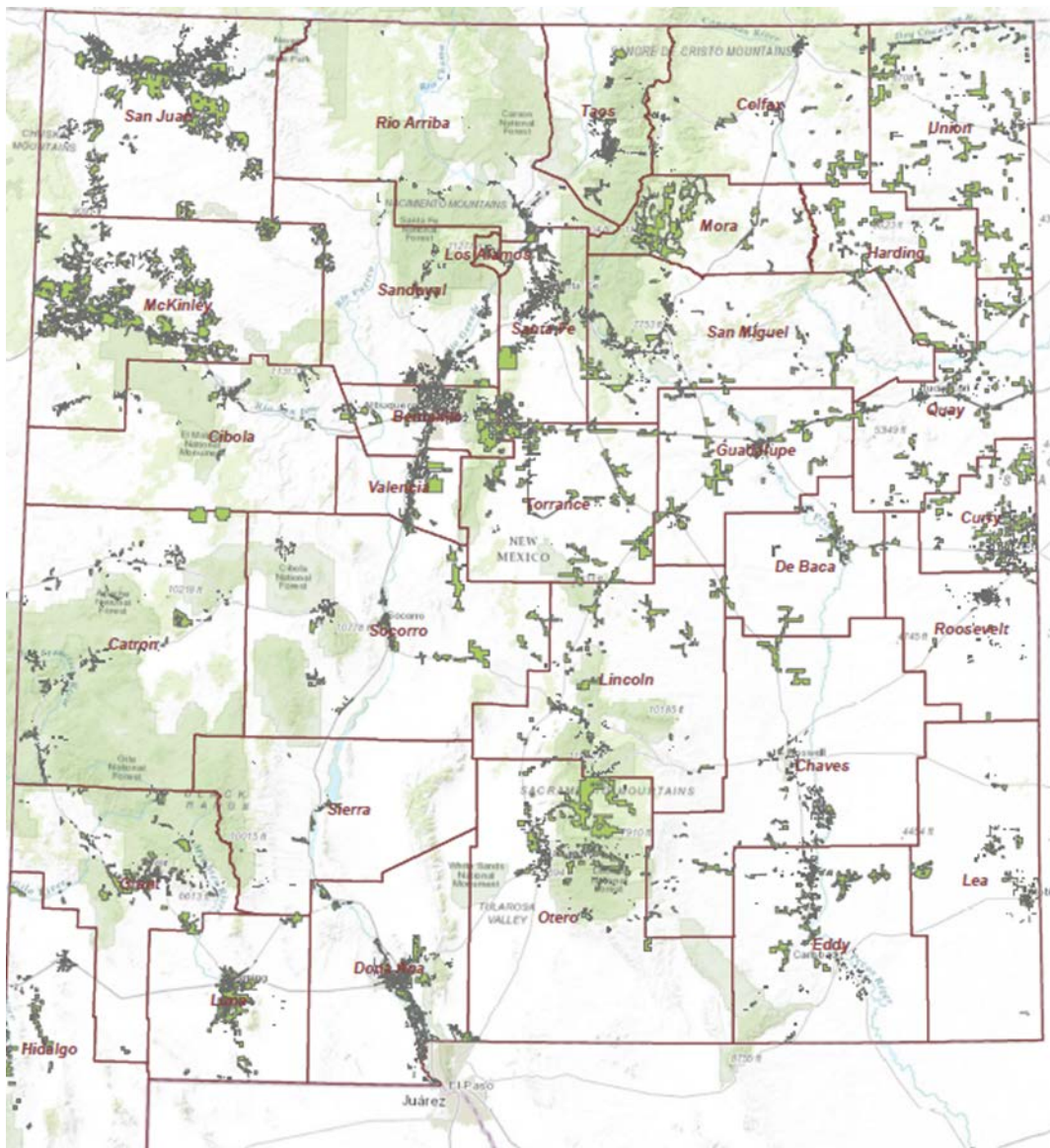

Figure 11: Areas with Only DSL That Are Not Eligible for CAF

Underserved Areas Identified During Gap Analysis

The intent of the gap analysis was to identify areas with less broadband availability and/or less broadband competition. Once these areas were identified using the NMBBP map, an in-depth analysis was carried out to examine individual census block areas to verify the accuracy of the data presented in NMBBP map. CTC also held discussions with providers that indicated that while many areas were indeed underserved, some data may not have been available to update the NMBBP map. A summary of the outreach to service providers in the State is outlined in Chapter 4.

In addition, field surveys were conducted, as outlined in Appendix E, to verify the broadband infrastructure availability and to develop approaches and cost estimates to improve services to underserved areas. Each of the three types of underserved areas are outlined below:

Commercial Corridors and Residential Developments

Within several of the larger cities in the State that were mainly served by cable or fiber providers, there are small areas that only have access to DSL services. These areas include shopping centers (as shown in Figure 12), small stores and industrial areas (as shown in Figure 13). In this figure, DSL-only coverage is indicated in green and cable coverage is indicated in brown. Red dots indicate business sites.

CTC also came across some schools and a few high-rise office buildings that had only DSL coverage (based solely on the NMBBP map). For instance, in the Albuquerque area, CTC identified over 30 gap areas with only DSL coverage. The historic downtown of Santa Fe also areas that fall into this category.



Figure 12: Broadband Coverage in Area Around the Mall Along Uptown Loop Rd NE in Albuquerque



Figure 13: Broadband Coverage in Industrial Area Along Industrial Avenue NE in Albuquerque

In most of the cities with cable or fiber coverage, CTC also noticed gaps in service to residential locations. These gaps were present in apartment complexes, mobile home parks, and single-family homes, as shown in Figure 14. DSL-only coverage is indicated in green and cable coverage is indicated in brown. Residential locations are noted in this study because they may also serve as sites for home-based small business operations or telecommuting.



Figure 14: Broadband Coverage at Sample Apartment Complex Along Montano Street in Santa Fe

The cities in which CTC noticed these types of gaps include: Albuquerque, Santa Fe, Las Cruces, Alamogordo, Los Alamos, Clovis, Silver City, Rio Rancho, Farmington, Deming, Hobbs, Los Lunas, Bernalillo, Corrales, Bloomfield, Belen, Kirtland, Lee Acres, Aztec, Truth or Consequences, and Los Ranchos de Albuquerque.

Outlying Areas of Large and Medium-Sized Cities

Some outlying areas that are typically less populated areas tend to have fewer broadband options. This may have been the result of the initial lack of customer density for providers to yield sufficient return on investment as they construct broadband in a city.

Figure 15 and Figure 16 depict examples of the businesses located within these areas. DSL-only coverage is indicated in green and cable coverage is indicated in brown. Red dots indicate business sites.

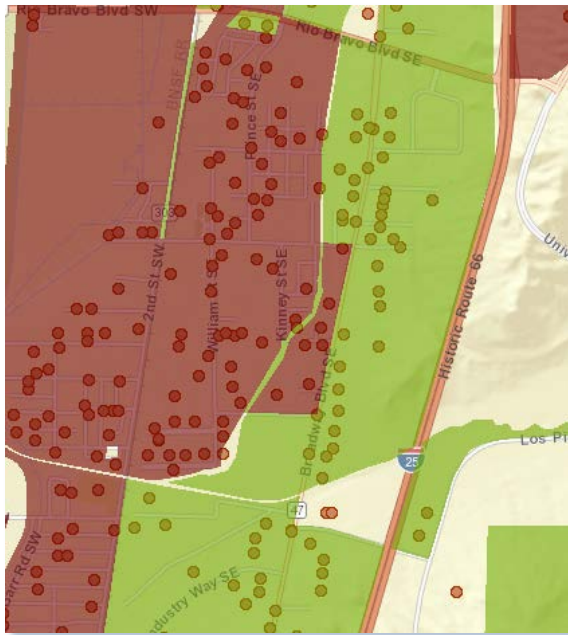

Figure 15: Broadband Coverage and Stores Along Broadway Boulevard SE in Albuquerque

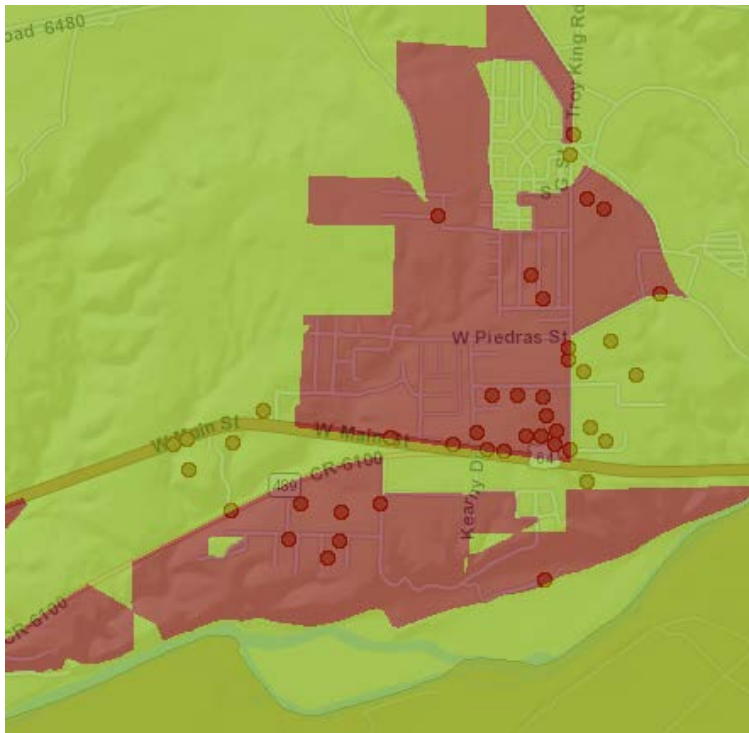

Figure 16: Broadband Coverage Along West Main Street in Farmington

Smaller Cities Mostly or Entirely Unserved by Fiber or Cable

Many smaller cities have only DSL coverage across over 90 percent of the city. These cities include Socorro, Chapparral, Lovington, Espanola, Zuni Pueblo, Grants, and Shiprock. Figure 17 depicts the broadband coverage in Socorro and the businesses within the City, with DSL-only coverage indicated in green. Red dots indicate business sites.

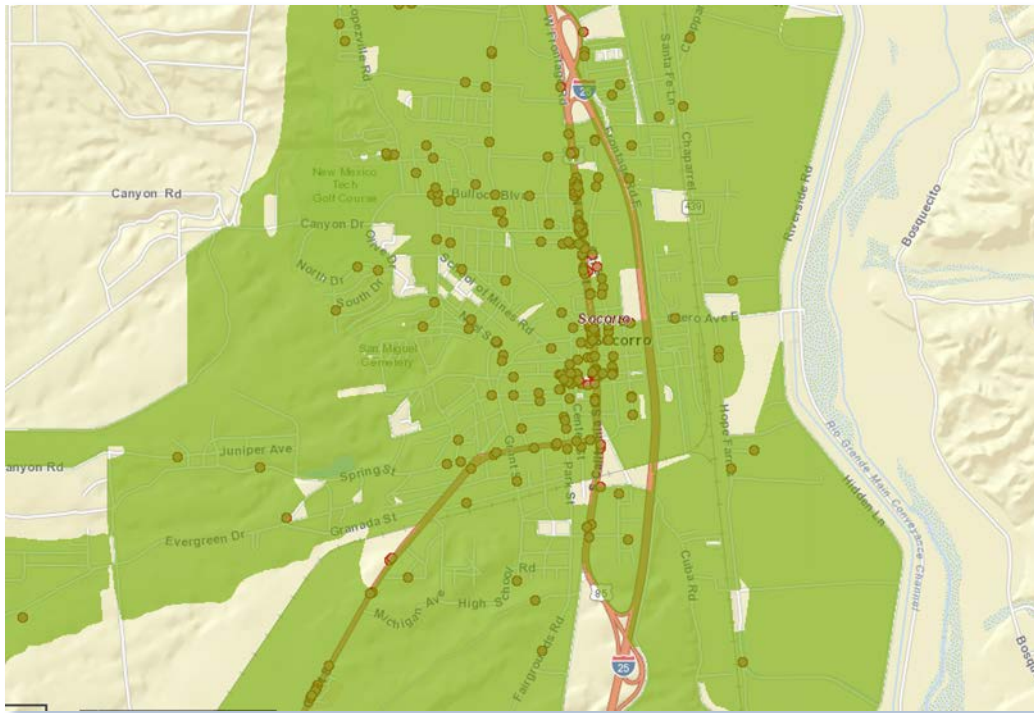

Figure 17: Broadband Coverage in Socorro

Coverage Discrepancies in the New Mexico Broadband Map

The field and Google Earth surveys revealed several areas where the coverage data in the New Mexico Broadband Map did not match the visible telecommunications plant. This coverage data is self-reported by service providers, collected from various publicly available sources, and crowdsourced directly from consumers. The discrepancies may be due to outdated, incomplete, or misreported data. It may also be the case that telephone and coaxial cable TV plant exists in these areas but is not being used to provide broadband services. Further clarification from the individual telecom operators is needed to provide an accurate measure of broadband service in these areas.

The following areas are indicated in the New Mexico Broadband Map as having DSL-only or no service, but appeared to have CATV infrastructure: Socorro, most of Rio Rancho, Pojoaque, Espanola, Santa Rosa, and the Casino at the Downs in Albuquerque.

Further information about the discussions with New Mexico service providers can be found in Chapter 4, and the field and Google Earth surveys are discussed in detail in Appendix E. The recommendation regarding funding for OBG’s mapping efforts and related programs are in Chapter 5.

Underserved Businesses by County

CTC also determined the percentage of businesses that are underserved (i.e., only DSL service available) in each county within the state. The number of underserved businesses (as a sum, and as a percentage of total businesses) is provided in Table 1. CTC also explored the correlation between population density and the extent to which businesses are underserved. Figure 18 is a scatter plot depicting the percentage of underserved businesses in a county relative to its population density.

CTC noted that while there is no uniform pattern in the lack of broadband based on population density, the

overall trend is that counties with lower population density (less than six persons per square mile) have a higher percentage of underserved businesses. The businesses in most of these counties (with at least 30 underserved business locations) are underserved by over 35 percent.

Table 1: Percentage of Underserved Businesses by County

Name of County (in descending order of population density)	Population Density (per square mile)	Number of underserved businesses	Percentage of underserved businesses (%)
Bernalillo	578.23	2853	4.7
Los Alamos	163.28	14	1.1
Santa Fe	77.23	1298	8.0
Valencia	71.43	274	8.4
Dona Ana	56.07	1219	13.4
Sandoval	36.81	445	7.5
Curry	35.99	122	4.3
San Juan	22.94	969	12.3
Lea	15.49	642	15.5
Taos	15.00	628	29.1
McKinley	13.45	477	17.2
Eddy	13.26	68	2.2
Chaves	10.84	22	0.6
Otero	9.90	294	11.0
Luna	8.32	258	23.9
Roosevelt	8.15	87	9.4
Grant	7.39	123	7.5
Rio Arriba	6.84	777	44.7
San Miguel	6.05	881	53.2
Cibola	6.02	792	76.4
Torrance	4.70	467	79.8
Lincoln	4.16	28	1.4
Colfax	3.49	618	72.0
Quay	3.03	229	40.3
Sierra	2.77	17	2.5
Socorro	2.65	497	77.5
Mora	2.44	64	65.3
Guadalupe	1.50	120	37.5
Hidalgo	1.35	198	62.7
Union	1.14	13	6.4
De Baca	0.82	2	3.6
Catron	0.52	93	49.7
Harding	0.33	3	4.7
Total	–	14,592	–

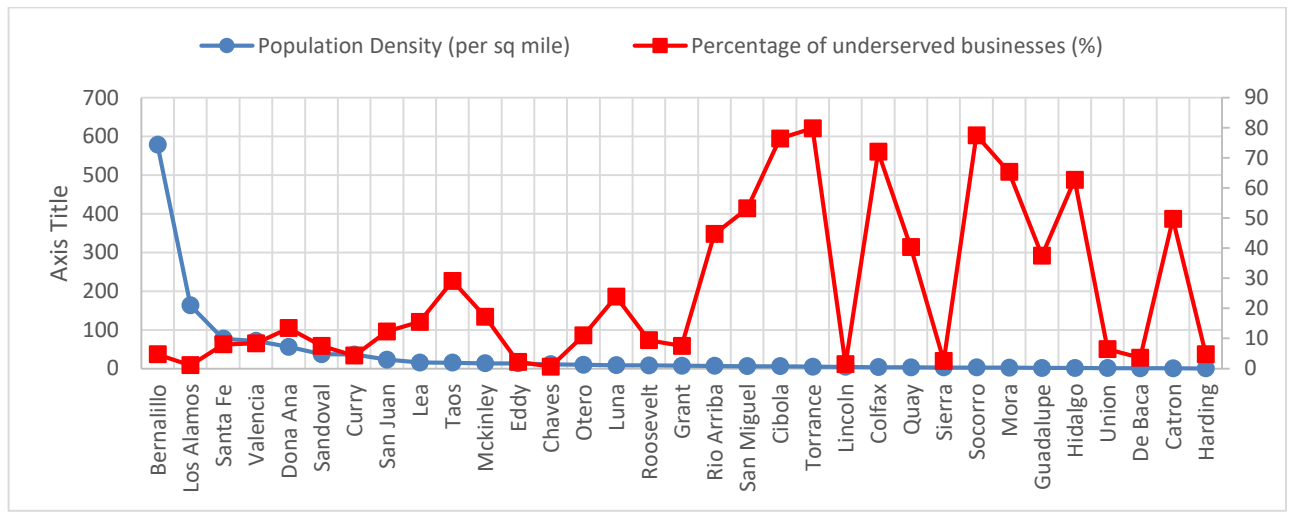

Figure 18: Population Density by County Versus Percentage Underserved Businesses

Chapter 2: Technical Approaches for Broadband Expansion

There are several potential approaches to broadband service and expansion. This chapter provides an overview of the major wireline broadband technologies: fiber optics, cable broadband, and copper DSL. It also provides an overview of fixed wireless technology and mobile broadband services.

The technologies are presented in decreasing order of capability to provide background and context for the current service level and the expansion recommendations.

Fiber Network Expansion

For several decades, fiber optic networks have consistently outpaced and outperformed other commercially available physical layer technologies, including countless variants of telephone and cable technologies. Telephone, cable, and wireless networks all use fiber optics in their core—no matter what technology is used for the final connection to the business or house, most of the communications path is over fiber optics, and the amount of fiber optics in a network is the best general indicator of a network's overall capacity and reliability.

Compared to other topologies, fiber-based optical networks provide the greatest overall capacity, speed, reliability, and resiliency. Fiber optics are not subject to outside signal interference, can carry signals for longer distances, and do not require amplifiers to boost signals in a metropolitan area broadband network. If an internet service provider (ISP) were to build new with no constraints based on existing infrastructure, it would likely begin with a fiber-to-the-premises (FTTP) access model for delivery of all current services. Compared to other infrastructure, an FTTP investment provides the highest level of risk protection against unforeseen future capacity demands. In cases where a provider does not deploy fiber for a new route, the decision is often due to the provider's long-term investment in copper or cable infrastructure, which is expensive to replace and may be needed to support legacy technologies.

Architecture

Figure 19 is a logical representation of an FTTP network. It is intended to illustrate the primary functional components, their relative position to one another, and the flexible nature of the architecture to support multiple subscriber models and classes of service. Some FTTP operators use passive optical network (PON) technology (Figure 20), splitting the fiber capacity in a neighborhood cabinet to connect up to 64 users. This architecture is cost-effective but provides less capacity per user than a direct fiber network (also known as Active Ethernet (AE)). However, it is still able to sustain more than 100 Mbps per user. Currently, deployed PON networks have a capacity of 2.5 Gbps/622 Mbps (GPON) or 10 Gbps/2.5 Gbps (10GPON) for a single shared PON.⁸

Active Ethernet (AE) provides a symmetrical (same speed up/down) service that is commonly referred to as Symmetrical Gigabit Ethernet. AE is typically deployed for customers who require symmetrical service or specific service level agreements that are easier to manage and maintain on a dedicated service. For subscribers receiving AE service, a single dedicated fiber goes directly to the subscriber premises with no splitting. Because AE requires dedicated fiber (home run) there is a significant cost differential in

provisioning an AE subscriber versus a GPON subscriber. The network operator selects electronics based on the mix of services it plans to offer and can modify or upgrade electronics to change the mix of services.

To upgrade the network, the operator need only upgrade the network electronics, rather than having to replace the cables.

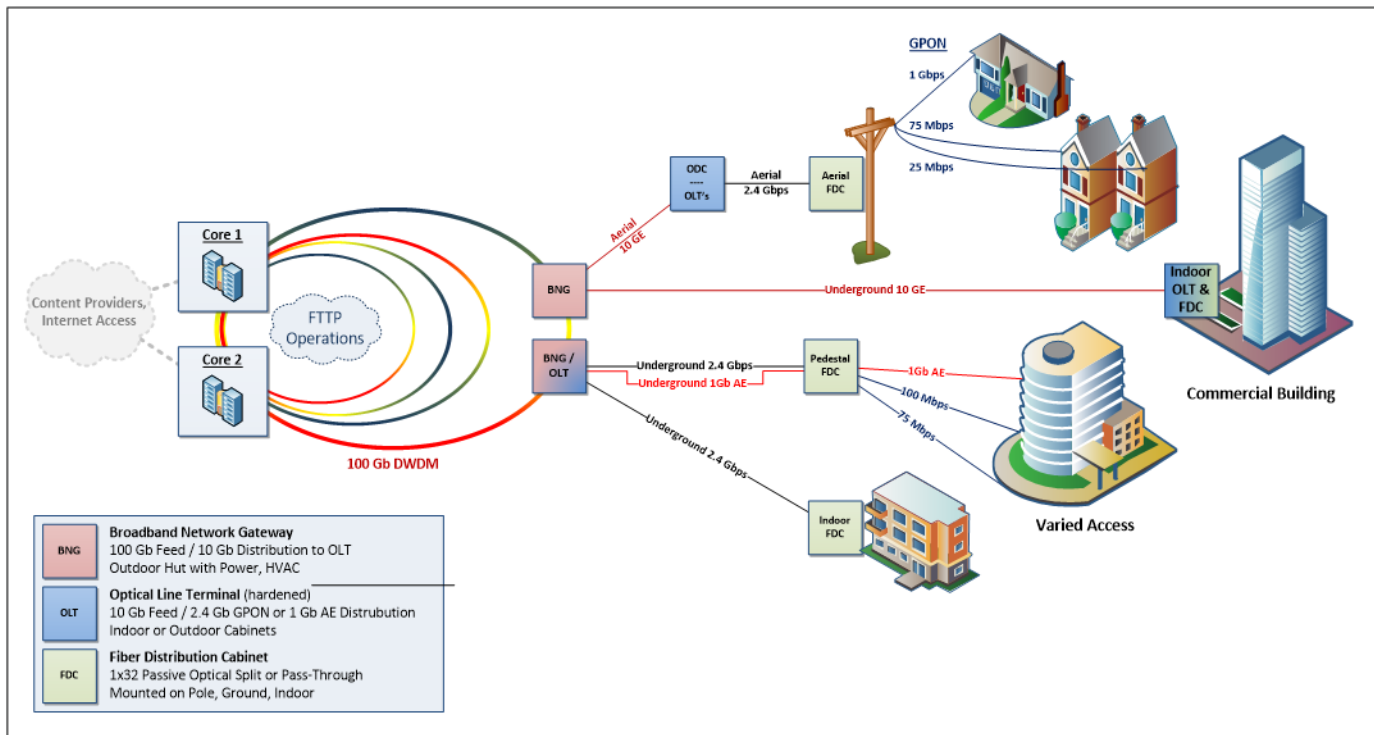

Figure 19: High-Level FTTP Architecture

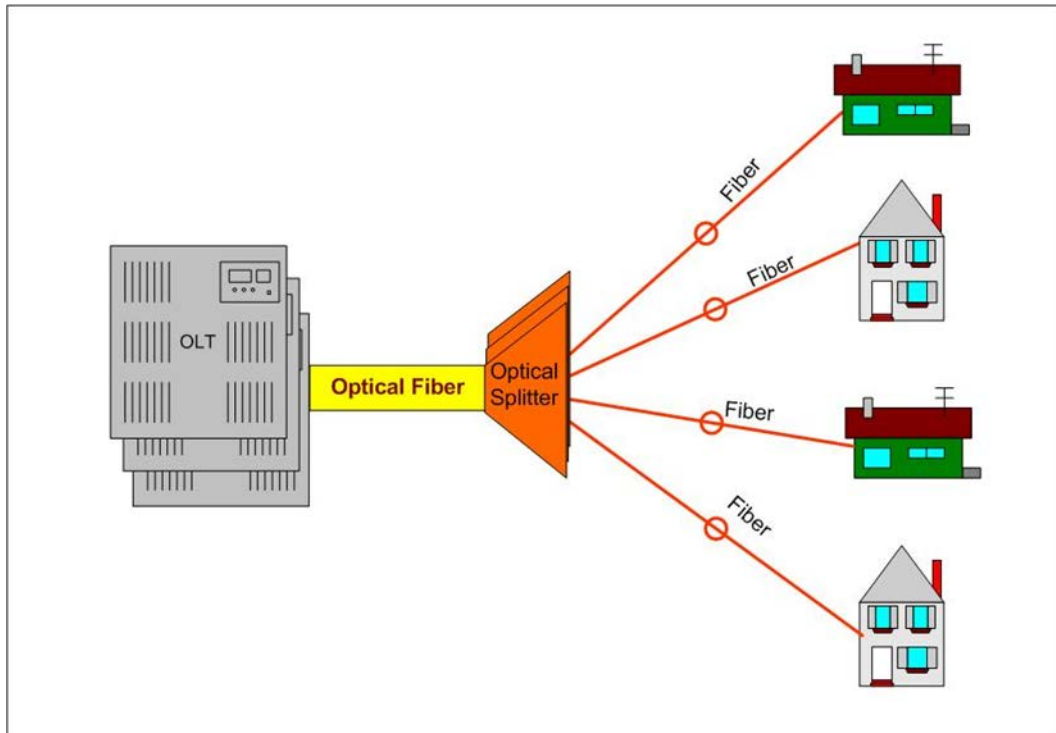

Figure 20: FTTP PON Network Architecture

Network Expansion Costs

The cost components for fiber construction include the following tasks:

- **Engineering** – System-level architecture planning, preliminary designs and field walk-outs to determine candidate fiber routing; development of detailed engineering prints and preparation of permit applications; and post-construction “as-built” revisions to engineering design materials.
- **General Outside Plant Construction** – All labor and materials related to “typical” underground or aerial outside plant construction, including conduit placement, utility pole make-ready construction, aerial strand installation, fiber installation, and surface restoration; includes all work area protection and traffic control measures inherent to all roadway construction activities.
- **Special Crossings** – Specialized engineering, permitting, and incremental construction (material and labor) costs associated with crossings of railroads, bridges, and interstate / controlled access highways.
- **Backbone and Distribution Plant Splicing** – All labor related to fiber splicing of outdoor fiber optic cables.
- **Backbone Hub, Termination, and Testing** – Material and labor costs of placing hub shelters and enclosures, terminating backbone fiber cables within the hubs, and testing backbone cables.
- **FTTP Service Drop and Lateral Installations** – All costs related to fiber service drop installation, including outside plant construction on private property, building penetration, and inside plant construction to a typical backbone network service “demarcation” point; also includes all materials and labor related to the termination of fiber cables at the demarcation point.

- **Customer Premises Equipment (CPE)** – Electronic equipment installed at a subscriber’s home or business. The service installer uses a pre-connectorized drop cable to connect the tap to the subscriber premises without the need for fiber optic splicing. The drop cable extends from the subscriber tap (either on the pole or underground) to the building, enters the building, and connects to CPEs.
- **Quality Control / Quality Assurance** – Expert quality assurance field review of final construction for acceptance.

A very high-level cost estimate for the areas CTC is evaluating in the State assumes an average construction cost of \$75,000 per mile or \$15 per foot. Actual costs may vary due to currently unknown factors, including:

- 1) Costs of private easements,
- 2) Utility pole replacement and make ready costs,
- 3) Variations in labor and material costs, and
- 4) Subsurface hard rock.

The FTTP fiber expansion costs typically vary by the following factors:

- Number of miles of fiber construction
- Percentage of underground and aerial fiber
- Cost of underground fiber
- Cost of aerial fiber along with number of poles per mile

The electronics needed to provide 1 Gbps speed over a fiber-to-the-premises (FTTP) network are widely available at an affordable price, and the price of the electronics needed to support 10 Gbps connections are declining rapidly.

There are costs for integration and implementation needed for customer premises electronics at business locations. Network integration would typically be approximately 25 percent of the network electronics costs.

Some of the annual operating costs for the network would include:

- Staffing (technicians, program manager, customer support)
- Outside plant (OSP) maintenance and relocates
 - 1 percent of construction cost per year
- Utility locating
 - \$3,500/week/urban area
- OSP incidentals and contingency
- Electronics maintenance fees starting in the year after electronics is deployed
- Facilities and utilities and office/back-office allocations
- Network Operations Center (NOC)
 - Based on \$150 per element per month
- Pole attachment fees
 - \$20 per year per attachment at approximately 30 poles per mile in rural areas and 40 poles in urban areas. Poles are spaced at greater distances in rural than in urban areas.

Cable Network Expansion

Architecture

Cable broadband technology is currently the primary means of providing broadband services to homes and businesses in most of the United States. Coaxial cables were originally designed to provide video services, but as demand for data capacity increased, coaxial networks became insufficient to support high-speed services. On an increasingly large scale, cable operators are now deploying fiber to replace large portions of their networks because, for a given expenditure in communications hardware, fiber can reliably carry many times more capacity over many times greater distances than coaxial cable or any other communications medium. Thus, coaxial cable networks have transformed into hybrid fiber-coaxial (HFC) networks.

In an HFC network, hub locations house the core transmission equipment. Fiber connections extend from these hubs to multiple nodes, each of which serves a given geographical area (e.g., a neighborhood). These optical nodes are electronic devices located outdoors, attached to aerial utility lines, or placed in pedestals. The equipment in the node converts the optical signals carried on fiber into electronic signals carried over coaxial cables. Coaxial cable then carries the video, data, and telephony services to individual customer locations.

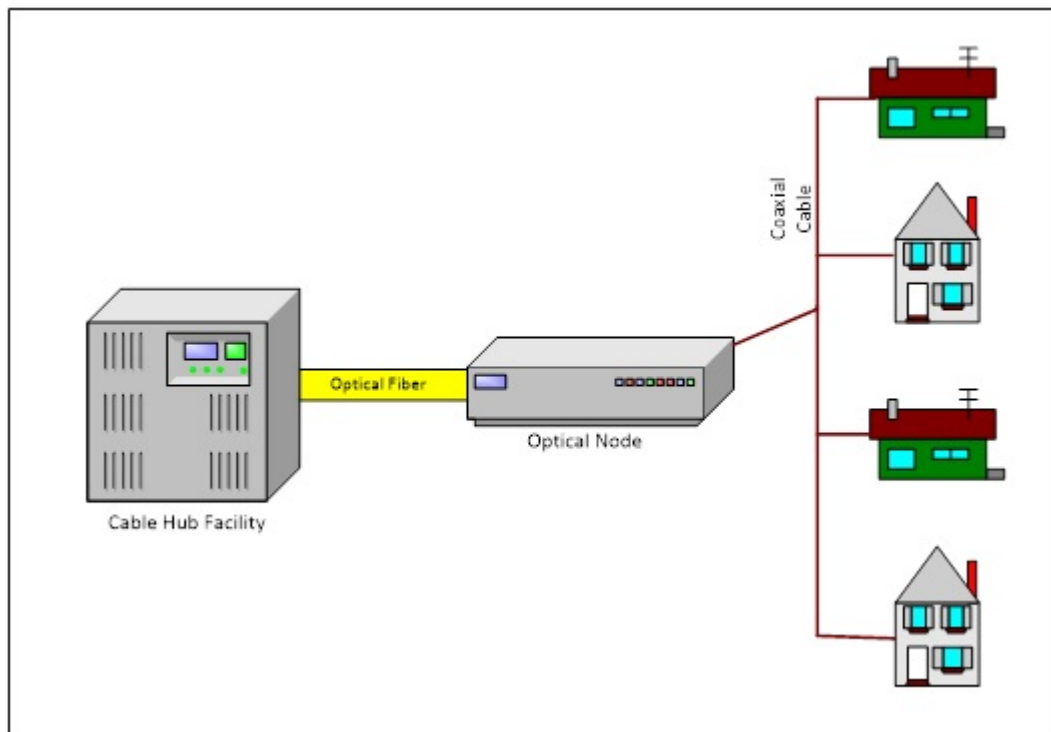

Figure 21: HFC Network Architecture

The current leading cable technology for broadband data, known as data over cable service interface specifications version 3.0 (DOCSIS 3.0), makes it possible for cable operators to increase capacity relative to earlier cable technologies by bonding multiple channels together. The DOCSIS 3.0 standard requires that cable modems bond at least four channels, for connection speeds of up to 200 Mbps downstream and 108

Mbps upstream (assuming use of four channels in each direction). A cable operator can carry more capacity by bonding more channels.

It is critical to note that these are peak speeds, and that the capacity is shared by all customers— typically hundreds of homes or businesses—on a particular segment of coaxial cable. Speeds may decrease during bandwidth “rush hours,” when more users simultaneously use greater amounts of bandwidth. For example, residential bandwidth use typically goes up considerably during evening hours, when more people use streaming video services and other large data applications.

The cable industry states that DOCSIS 3.1 will provide 10 Gbps downstream capacity and 1 Gbps upstream. This will not be possible for most actual cable systems—a typical system with 860 MHz capacity might have the first 192 MHz assigned to upstream, leaving approximately 660 MHz for downstream.⁹ Even with 10 bps/Hz efficiency, the actual downstream capacity for a shared node area would be closer to 6 Gbps than 10 Gbps, and that capacity will be aggregated among a few hundred users.

Expansion of downstream spectrum to 1.2 GHz (and potentially to 1.7 GHz) is also being considered.¹⁰

Cable operators often offer services with “blast” or “burst” speeds of “up to” more than 100 Mbps. Although a customer may be able to access these speeds on occasion, the actual speeds available will probably be significantly lower during peak usage hours.

Network Expansion Costs

Cable operators have extended fiber optics progressively closer to their subscribers, but for cost reasons have generally stopped at nodes about one mile from the premises. The most significant part of the investment in expanding an HFC network is the fiber construction cost.

DSL Network Upgrades

Architecture

During the last century, phone companies connected virtually every home and business in the U.S. to a pair of copper wire. Because of the ubiquity of copper, digital subscriber line (DSL) technology over copper has been an important way for people to connect to the internet. There is no need for extensive hardware or wire installation as the copper wire is already run to most buildings. Equipment such as modems are needed, but overall the fact that DSL can send digital data over regular phone copper wires made it less costly to implement a DSL network because the infrastructure is already in place.

The greatest disadvantage of DSL service is its dependence on proximity to the central office (CO). The farther one is from the central office, the slower the bit rates. Amplifiers may be used to enhance this to some extent. In addition to the problems associated with distance, there can be network congestion at the central office, slowing the data speeds. Also, DSL service relies on copper wires, many of which have been installed decades ago and can be of low quality or damaged since many local phone companies are not maintaining their copper network if they have deployed fiber in that route. Because of this, they may not be able to support high-speed DSL or may only work for very short distances from the CO.

Each user must have a DSL modem or a transceiver to access the internet. The transceiver is at the user end and communicates directly with the CO, the place where one’s DSL service ‘originates,’ via a DSL

Access Multiplexer (DSLAM). The DSLAM aggregates all the user's data and information. Figure 22 shows the schematic of a common DSL network.

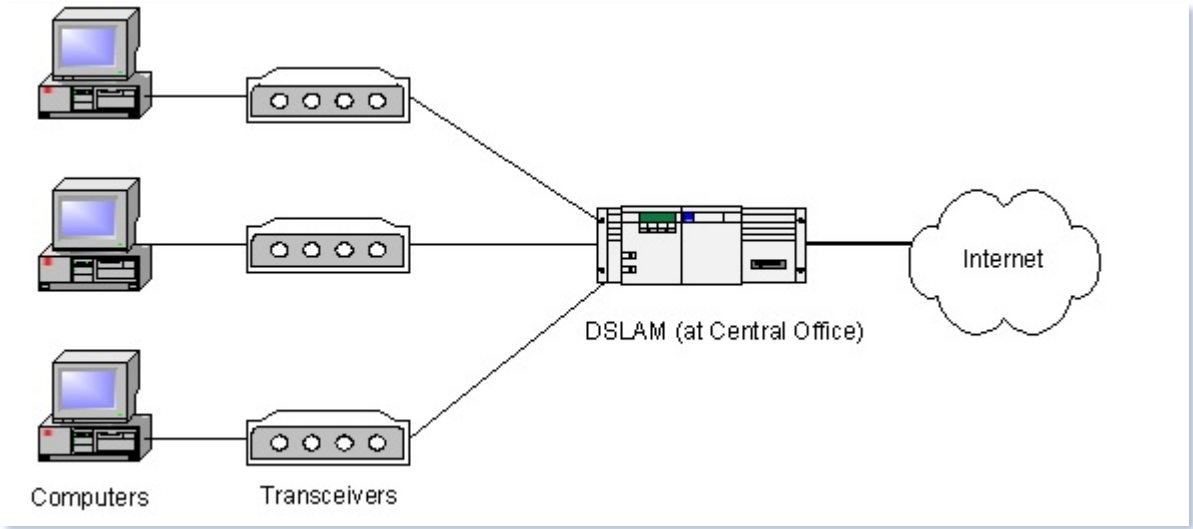

Figure 22: DSL Network Architecture

There are several different types of DSL such as ADSL (Asymmetric DSL), ADSL2+ and VDSL (Very high rate DSL). The main determinant of DSL speed is the length of the copper line from the telephone company central office. In systems operated by large telecommunications companies, the average length is 10,000 feet, corresponding to available DSL speeds between 1.5 Mbps and 6 Mbps. In systems operated by small companies in rural areas, the average length is 20,000 feet, corresponding to maximum speeds below 1.5 Mbps. The fastest version that is deployed, VDSL-2, is limited to 3,000 feet over typical copper lines and require fiber to the node (FTTN)—much closer than in most HFC systems. Therefore, to operate VDSL and VDSL-2, telecommunications companies must invest in large-scale fiber optic construction and install remote cabinets in each neighborhood.

To overcome the inherent limits of copper cable, some operators bundle multiple copper pairs. In practice, telephone companies using VDSL-2 over highly upgraded copper lines have been able to provide 25 Mbps over a single copper pair and 50 Mbps over two pairs to the home or business—but it took a significant investment to make it possible for a small percentage of the copper phone lines to temporarily keep pace with cable. Providing even greater speeds will require some combination of even deeper fiber construction, a breakthrough in transmission technology over copper lines, and conditioning and upgrading of the existing copper lines.

Newer “G.Fast” technology standards enable speeds up to 1 Gbps over a single twisted-pair copper cable (and declining to about 150 Mbps as distances increase)¹¹ but are designed to work over short lengths of copper loop. It will still require significant investments to deploy fiber close to end-user premises.

Many telecommunications companies are minimizing their investment in copper lines. New investment in DSL is not future-proof and will likely be obsolete relatively soon.

Upgrade Costs

A significant part of the investment in expanding a DSL network involves the extending the fiber

construction closer to the end user. Thereafter, high speed DSL cards would be required at the CO and at the end user's premises (along with costs for building entry) to upgrade the last mile.

Fixed Wireless Network Connectivity

Wireless technologies can provide a solution in low-density rural areas where the high cost of building wired networks often leaves rural residents without a wired broadband option. Wireless ISPs (WISPs) are potentially able to fill these coverage gaps, sending signals from base stations to antennas on or near customer premises. WISPs are not able to offer connection speeds on a market-wide basis comparable to cable or fiber built to each premises. However, they may be the best available solution if cable or fiber is not cost-effective. Even in an urban setting, a WISP can create a point-to-point network from rooftop to rooftop with individual links in the Gbps range, connecting to fiber where it exists.

Architecture

Fixed wireless networks are built by WISPs with off-the-shelf equipment. They tend to have an aggregate capacity between 100 and 250 Mbps. With innovations like higher-order multiple input, multiple output (MIMO) antennas, and the use of spatial multiplexing, these capacities will likely increase to as fast as 750 Mbps. Smaller WISPs use the same unlicensed spectrum bands as Wi-Fi, which does not have strong long-distance transmission qualities.

Most wireless networking solutions require the antenna at the client site to be in the line of sight of the base station antenna. This can be especially challenging in mountainous regions. It is also a problem in areas with dense vegetation or multiple tall buildings. WISPs often need to lease space at or near the tops of radio towers; even then, some customers may be unreachable without the use of additional repeaters. And because the signal is being sent through the air, climate conditions like rain and fog can impact the quality of service.

Some wireless providers in rural areas have begun to use vacant television frequencies called TV white space (or simply white space) to provide service. These TV bands have much better non-line-of-sight transmission qualities than the unlicensed bands; however, because white space technology is still in an early phase of development, compatible equipment is far more expensive than other off-the-shelf wireless equipment.

Wireless equipment vendors offer a variety of point-to-multipoint and point-to-point solutions. A medium-sized business location would be more likely to obtain a point-to-point solution with dedicated bandwidth from the service provider to obtain the needed bandwidth and quality. Small businesses and residences would obtain a point-to-multipoint solution, which is more affordable to implement. Point-to-point networks may have limited network capacity, particularly in the upstream, making the service inadequate for applications that require high-bandwidth connections.

Network Expansion Costs

The following factors will determine the costs associated with a fixed wireless network:

- **Wireless equipment used:** Different wireless equipment have different aggregate bandwidth capacity and use a range of different spectrum bands, each with its own unique transmission capabilities.

- **Backhaul connection:** Although the bottleneck tends to be in the last-mile connection, if a WISP cannot get an adequate connection back to the internet from its tower, equipment upgrades will not be able to increase available speeds beyond a certain point.
- **Future capacity and lifespan of investment:** Wireless equipment generally requires replacement every five to 10 years, both because exposure to the elements causes deterioration, and because the technology continues to advance at a rapid pace, making decade-old equipment mostly obsolete. The cost of deploying a wireless network is generally much lower than deploying a wireline network, but the wireless network will require more regular investment.
- **Availability of unobstructed line of sight:** Most wireless networking equipment require a clear, or nearly clear, line of sight between antennas for optimum performance. WISPs often lease space near the tops of radio towers, to cover the maximum number of premises with each base station. In mountainous regions, many premises may not have a clear line of sight to a radio tower. Thus, additional “hop” infrastructure would be required to ensure a connection.

As with fiber, a business may “self-provision” a wireless network, installing antennas on rooftops and connecting multiple links back to the internet. In this case, the business would need to perform the engineering and installation, obtain space on towers and rooftops, and perform needed maintenance.

Mobile Broadband Connectivity

Cellular wireless carriers have been consistently increasing their data speeds with the rollout of faster and higher capacity technologies, such as Long-Term Evolution (LTE).¹² Over the past few years, they have provided data plans with speeds comparable and in many cases, greater than a typical residential customer’s internet service.

Wireless providers operate a mixture of third-generation (3G) and fourth-generation (4G) technologies, typically providing devices (telephones, smartphones, air cards, tablet computers) bundled with 3G or 4G services. Typically, devices are not portable from carrier to carrier, because they are “locked” into the carrier by software and/or because differences in the technologies used by the carriers limits compatibility of the devices (discussed below). Therefore, the purchase of a device is a de facto commitment to a particular service provider, as long as the user uses the device.

The strict definition of 4G from the International Telecommunications Union (ITU) was originally limited to networks capable of peak speeds of 100 Mbps to 1+ Gbps depending on the user environment;¹³ per that definition, 4G technologies¹⁴ are not yet deployed.

In practice, multiple existing technologies (e.g., LTE, WiMAX) are called 4G, and represent a speed increase over 3G technologies as well as a difference of architecture—more like a data cloud than a cellular telephone network overlaid with data services. The ITU and other expert groups have more or less accepted this.¹⁵

Because of its limited bandwidth and the cost of the bandwidth (typically metered), mobile broadband is not well-suited to connecting businesses. However, mobile broadband is a useful tool because of its ubiquity and the ease of connecting computers and devices to it.

Chapter 3: Recommended Technical Solutions for Underserved Areas

Improving broadband services in the underserved areas can be accomplished in a range of ways. As with any infrastructure, the exact cost and solution depends on the current state of a given area, the requirements in the underserved area, the rights-of-way, and the existing broadband providers in the area.

The objective of this chapter is to identify a range of potential strategies and the cost associated with them. By identifying strategies and systematic approaches, the goal is to help businesses move away from the current ad hoc approach to broadband that has led to pockets of underserved areas and high costs.

The methodology is to leverage existing telecommunications and cable providers to manage costs and minimize overlapping infrastructure. This approach is also intended to view existing service providers as partners in the effort.

The approaches outlined below are based on:

1. Discussions with service providers in the State of New Mexico,
2. Review of the service areas as discussed in Chapter 1,
3. Field surveys of the underserved areas, and
4. Expansion costs from comparable areas.

This section divides the approaches into the categories from Chapter 2—commercial corridors and residential developments, outlying areas of large and medium-sized cities, and services in smaller cities that are entirely underserved; and suggests technical expansion approaches and typical costs for each.

CTC also derived high-level cost estimates for a state-wide network expansion by extrapolating the costs for sample areas to other locations on the basis of street mileage and passings (i.e., number of potential service addresses).

High- and medium-density urban corridors tend to have more underground utilities; utilities are predominantly aerial in residential areas. Medium-density areas tend to have the greatest variation in the percentages of aerial versus underground construction. Generally, the newest subdivisions and developments tend to be entirely underground, whereas older neighborhoods have aerial construction. Suburban areas also tend to have more rear easements for utilities, which can increase the cost of construction.

CTC's observations determined that for low-density, utilities are primarily aerial, but the low density requires more construction of fiber to reach a smaller number of businesses. The high cost of constructing to low-density areas is often the reason for a lack of existing telecommunications services in these areas.

Small Commercial Corridors and Residential Developments

As discussed in Chapter 1, a large percentage of the underserved businesses are in contained pockets within commercial or residential areas that are served. This category comprises the “low-hanging fruit” in addressing broadband needs for businesses. Expanding a more suitable wireline service into those areas requires:

- A relatively short extension from the served area into the underserved area,
- Extension of laterals and service drops throughout the underserved area,
- Placement of customer premises equipment (CPE) on the customer premises, and
- Enhancement of the service provider network to address the increase in capacity upstream.

Network Expansion Description

The cost in this scenario is based on constructing fiber or coaxial cable along the shortest route from each business to the nearest fiber or coaxial service area. CTC assumed that the closest connection point is on average one-quarter mile away. Construction ranges from the straightforward use of existing pole line to underground construction primarily using directional boring techniques.

For construction within the underserved area, CTC assumed an industry-standard approach building the new facilities along the road, along the storefront area, or within the office park or building. CTC assumed on average one-tenth mile of new facilities, ranging from straightforward use of existing pole line to more-costly construction, requiring underground, under-road (parking lots in some cases), or in-building construction. CTC assumed on average 10 service passings per area.

Figure 23 illustrates a sample deployment of infrastructure to an underserved area. In this diagram, the area to be served is fed by fiber (pink line) that connects to a new node (blue box). New service drops (yellow lines) connect end users' premises.

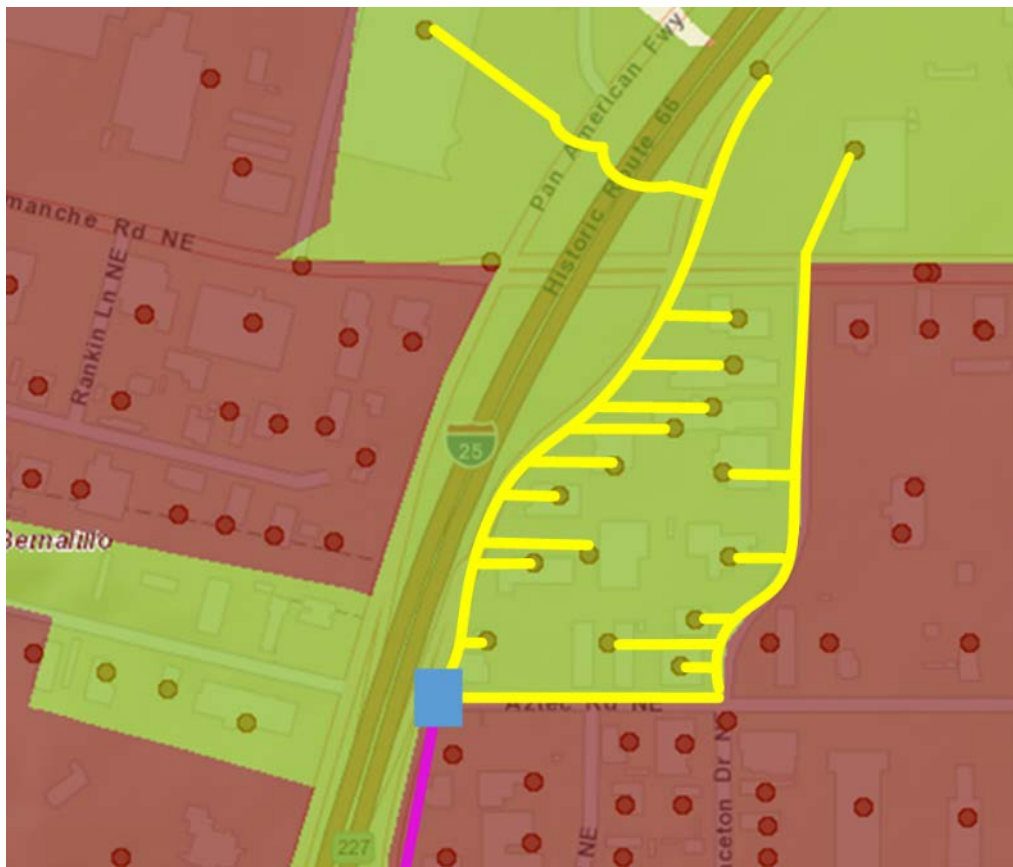

Figure 23: Underserved Area Fed by Fiber (Pink) to a New Node with New Service Drops (Yellow)

CTC assumed construction from the tap location to the business and use of existing cable pathways or building penetrations where possible. Again, there will be a low-end cost with aerial service drops (Figure 24) and building penetration near the existing telecom entry, and a high-end cost requiring indoor construction (Figure 25).

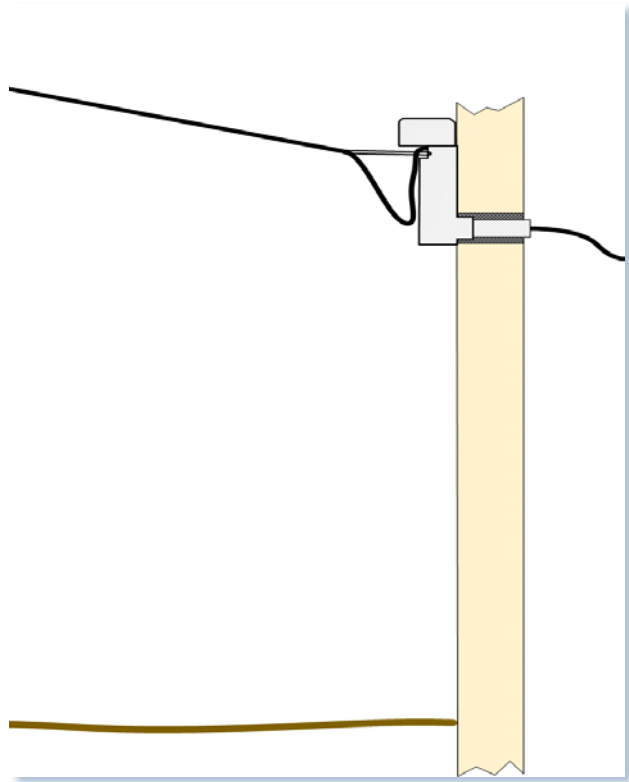

Figure 24: Aerial Building Entry

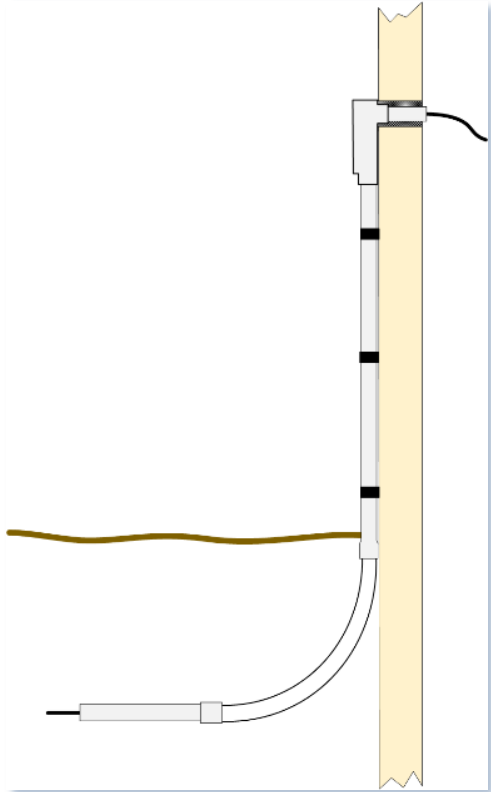

Figure 25: Underground Building Entry

Finally, CTC assumed the enhancement of network capacity to accommodate new services. The low-end of the enhancement would be on a cable modem network, where the DOCSIS network architecture is highly scalable and additional components will not be required, only electronic provisioning. The high end would be enhancement of DSL or fiber which would require additional port connections.

Table 2 provides a summary of the high-end and low-end expansion costs for expansion in a typical 10-business area. Based on CTC’s field survey, approximately 80 percent of the businesses fall closer to the low-end category, and 20 percent fall closer to the high-end category, providing an average expansion capital cost of approximately \$2,000 per business statewide for this scenario—assuming simultaneous construction and activation for a service area of at least ten businesses.

Table 2: Summary of Commercial Corridor Expansion Cost – Typical 10-Business Area

	Low End	High End
Extension from Served Area	\$6,000	\$30,000
Buildout in Underserved Area	\$2,400	\$12,000
Entry into Businesses	\$2,500	\$10,000
Enhancement of Network Capacity	\$250	\$1,000
Total	\$11,150	\$53,000

Figure 26 and Figure 27 show the gap areas within Albuquerque and Santa Fe which are mainly served by cable or fiber. The proximity of the cable or fiber improves the business case for expanding service to the gap areas.

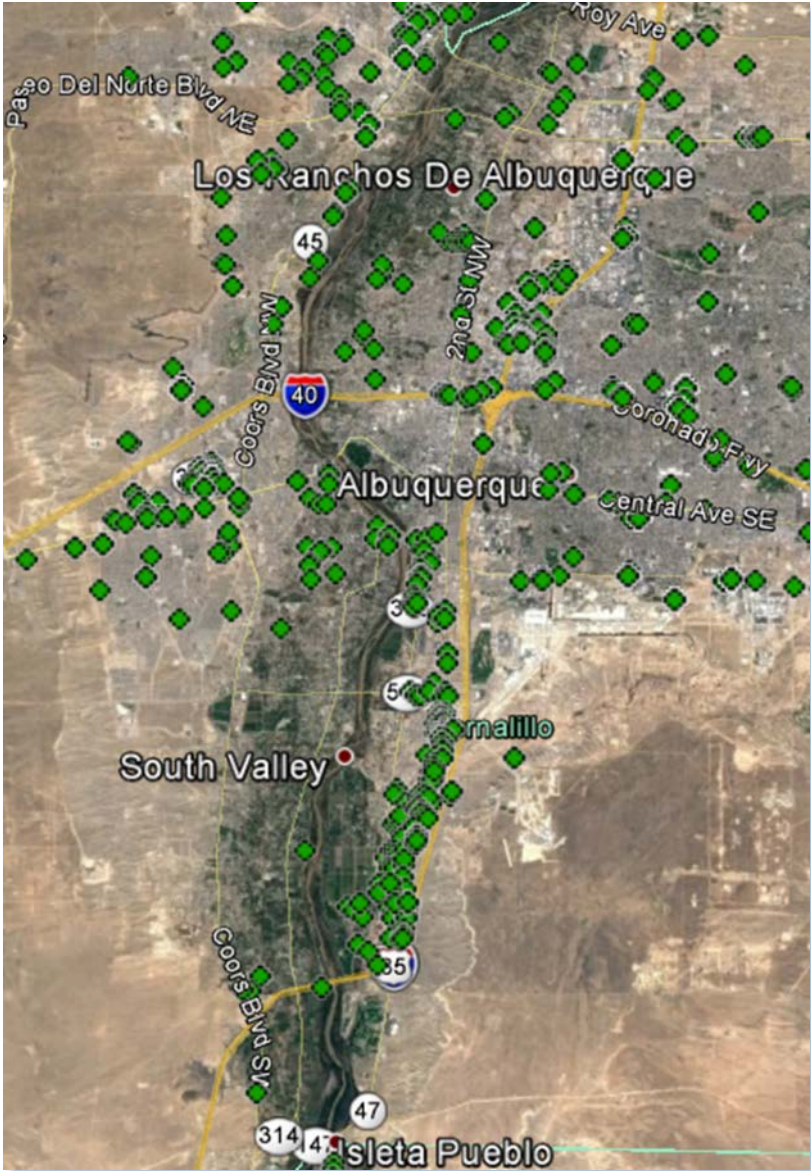

Figure 26: Underserved Businesses in the Albuquerque Area (with Only DSL Service)

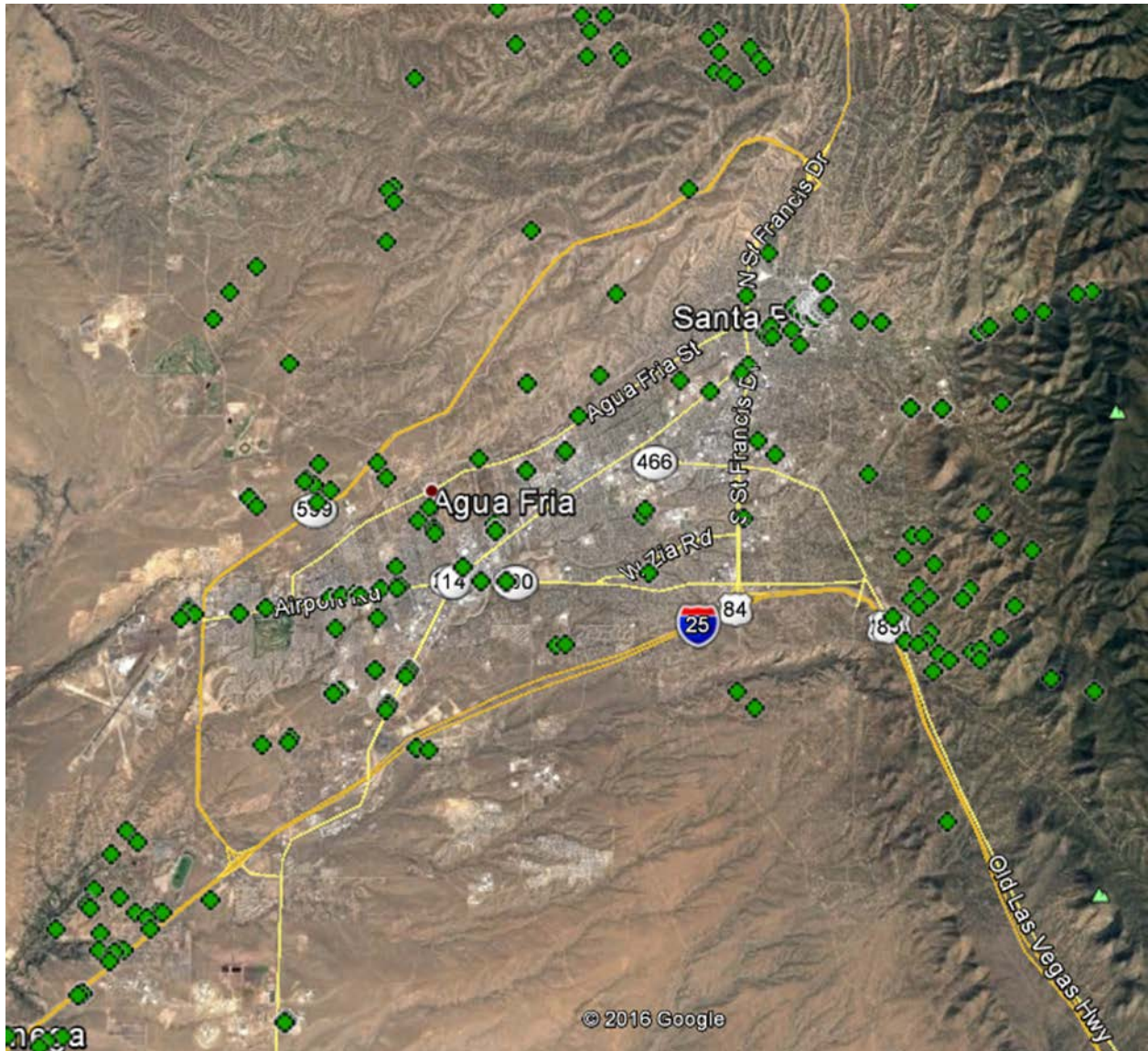

Figure 27: Underserved Businesses in the Santa Fe Area (with Only DSL Service)

In these areas, CTC assumed that the telephone operator already has fiber on each of the primary roads. For the local telephone operator in each community, the costs can be relatively low. This will not be feasible in the event that fiber is not on each of the primary roads, if any of the fiber owners are not cooperative partners, or if fiber is not available on those roads for some other reason.

Outlying Areas of Large and Medium-Sized Cities

In this scenario, there are entire neighborhoods that are not served, in outlying areas of large and medium-sized cities. This scenario differs from that discussed above in that the unserved areas exist both in large contiguous blocks and as small discrete areas. This may be the result of a decreased density or high build cost reducing the business case for deployment, of expansion of the city to new areas before a cable provider expands to the area, or the result of the cable franchise area not including some areas. Again, there are several possible approaches.

For cost estimation purposes, CTC considered a high-cost scenario in which a broadband provider expands its footprint of broadband from the served area. CTC also considered a lower-cost approach in which the telephone service provider upgrades the service in the area to higher speeds. While the high-end scenario will potentially provide service of hundreds of Mbps and further scalable with upgrades in network electronics, the low-end scenario is more likely in the 50 Mbps range and would require more construction to scale further.

Network Expansion and Upgrades

The cost is difficult to model hypothetically and depends on several factors—the main ones being density (number of passings per mile of cable), prevailing aerial or underground utilities, the availability of conduit or other cable pathways, surface type (dirt or pavement), permitting requirements, and prevailing labor costs. Because construction will be through existing neighborhoods and developments, it is unlikely the project will be able to leverage open trenches or road construction.

As an example, CTC considered build costs in the Broadway Blvd., SE, corridor in Albuquerque shown earlier in Figure 14. There are approximately 75 businesses in the underserved area. Prevailing utilities are about 75 percent underground with the right-of-way surface primarily dirt or gravel, enabling construction to be done using a mixture of plowing or boring, with relatively low restoration costs.

Considering a scenario with approximately six miles at an average construction cost of \$60,000 per mile for this scenario (which would be lower than the statewide average), the construction cost is \$360,000 or approximately \$5,000 per passing. Including building entry and subscriber equipment, increases the cost to approximately \$5,500 per passing.

Considering a lower-end alternative scenario that enhances the existing telephone infrastructure to VDSL-2 by bringing fiber and fiber cabinets within one-half mile of each premises, the construction distance can be reduced to 1.75 miles, reducing the cable construction cost to approximately \$100,000. Adding cabinets and termination equipment increases this cost to \$200,000, or \$2,800 per passing.

The Broadway Blvd., SE, area in southern Albuquerque is a large area, where network expansion can be done with significant economies of scale, and has relatively high density as compared with other areas. Areas with lower density, or in built-up areas with more costly restoration requirements, will have higher costs per passing.

Because of the potentially large range in cost, rather than adopting a standard per-business metric, CTC recommends an approach where a service provider or an engineering firm provides an estimate or a competitive bid on a project-by-project basis to estimate the cost.

Smaller Cities Mostly or Entirely Unserved by Fiber or Cable

As discussed in Chapter 2, there are small communities mostly or entirely unserved by fiber or cable broadband. Figure 28 illustrates these areas (in blue), many of which are not adjacent to fiber or cable services areas, and comprising most small cities in New Mexico.

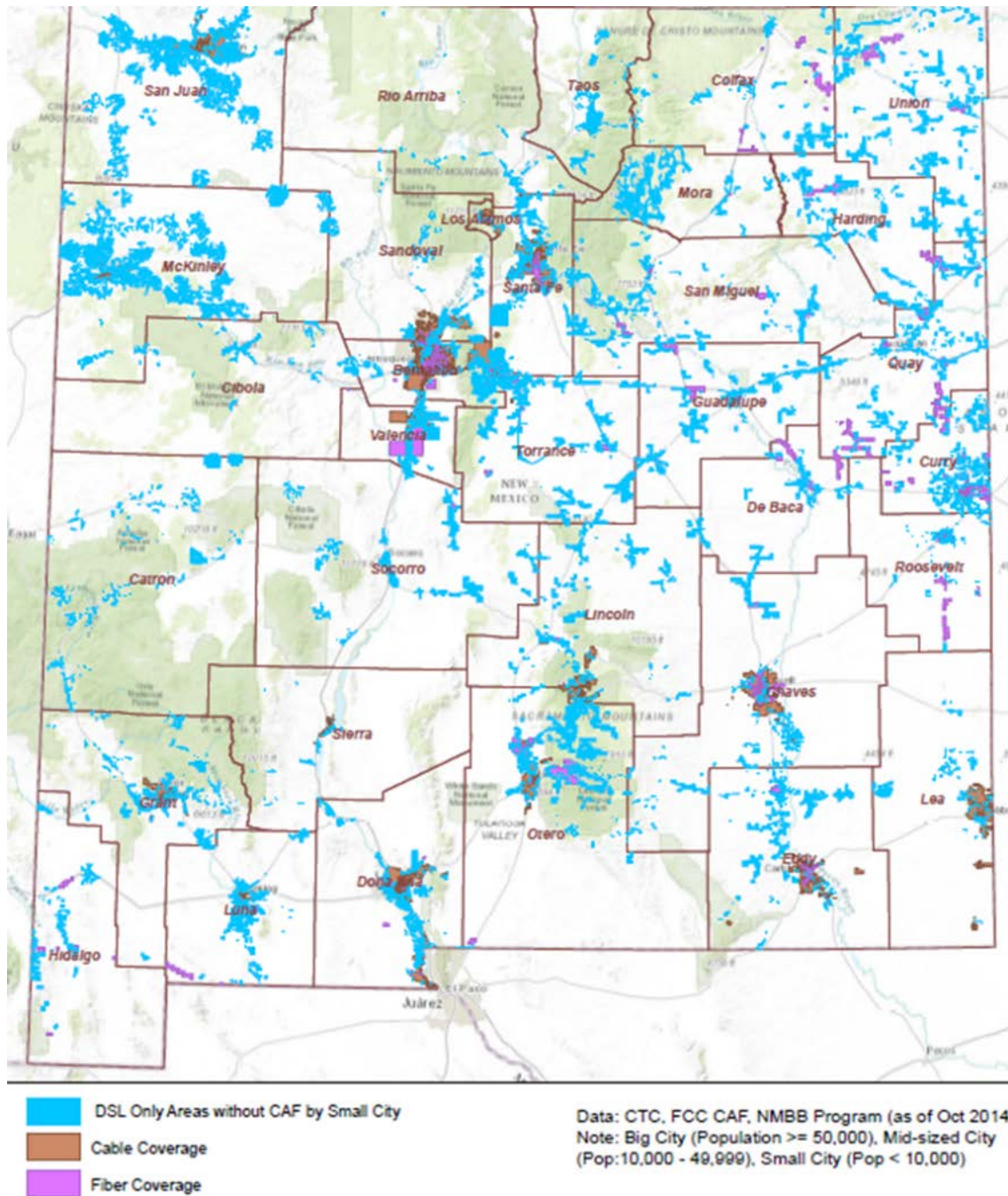

Figure 28: Underserved Areas in Small Cities That Are Not Near Existing Cable or Fiber

CTC found that these cities fall into two categories—one in which there is coaxial cable in place not providing broadband, that potentially could be upgraded to provide service—and another in which only telephone service is available. The first category provides a potentially cost-effective fix that can provide greatly improved broadband. The second is more complex and requires a case-by-case analysis, considering the number of businesses who are underserved, the level of improvement they need, and the upgrade cost in a wide range of technical scenarios—including use of the existing telephone lines, wireless options, and construction of a new network.

Network Expansion and Upgrades

For the first category, CTC recommends an upgrade of the cable service in the community to provide two-way broadband service. This typically requires expansion of the fiber portion of the network to within approximately one-half mile of each premises, as depicted in Figure 29, and also requires upgrade of the power supplies and amplifiers on the system, and requires replacement of older network components. It also requires electronics and systems for broadband cable, and interconnection with the internet backbone.

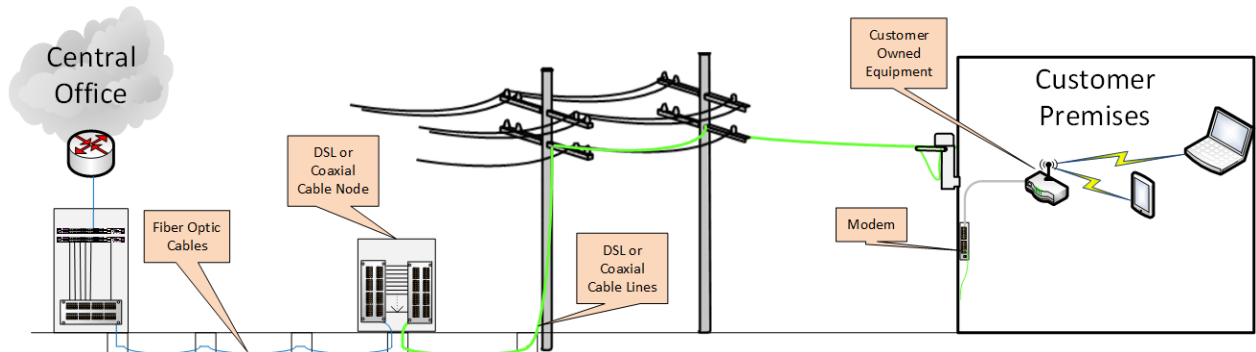

Figure 29: DSL or CATV Network with Fiber Extended to a Node Close to the Customer Premises to Enhance Network Capacity

The upgrade is comparable to what was done in cable broadband-served areas in the 1990s. The cable providers in New Mexico are mostly multi-system operators with cable broadband service for most customers. This will enable them to leverage existing expertise and resources in the upgrade. Upgrade cost depends on a wide range of factors, but historically this cost averages \$500 per passing. Thus, a town with 2,000 homes and businesses would cost approximately \$1 million to upgrade.

For the second category, there is no coaxial cable to be upgraded, and the alternatives are to provide upgraded services over the existing copper lines, or to build a new wireline broadband network, such as a fiber optic network as depicted in Figure 30.

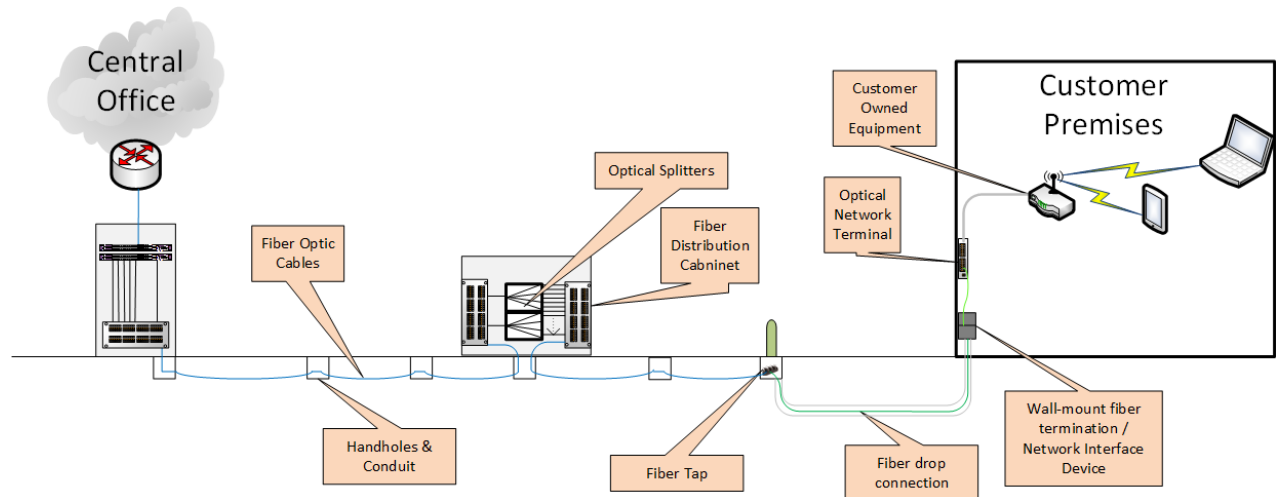

Figure 30: GPON Fiber Network with a Buried Service Drop

There is also the option to build a wireless network, which, though not having the speed or scalability of a wired network, could still greatly increase the network speeds relative to the existing services.

Network Expansion Cost Estimates: Underserved Businesses in Bernalillo County

Bernalillo County has 2,853 business locations that are underserved (out of a total of 60,213 businesses).¹⁶

Figure 31 and Figure 32 show the distribution of these businesses within the county. Figure 33 depicts the availability of cable or fiber networks relative to the locations of the businesses. CTC conducted a high-level cost estimation to expand broadband connectivity to these businesses from the existing networks, based on the above methodology.

Actual costs may vary due to unknown factors, including the costs of private easements, utility pole replacement, and make-ready; variations in labor and material costs; and a providers operational and business model.

As with any utility, the design and associated costs for construction will vary with the unique physical layout of the service area; no two streets are likely to have the same configuration of fiber optic cables, communications conduit, underground vaults, and utility pole attachments.

Costs will further vary due to soil conditions, such as the prevalence of subsurface hard rock; the condition of utility poles, copper lines and the feasibility of aerial construction involving the attachment of fiber infrastructure to utility poles; and crossings of bridges, railways, and highways.

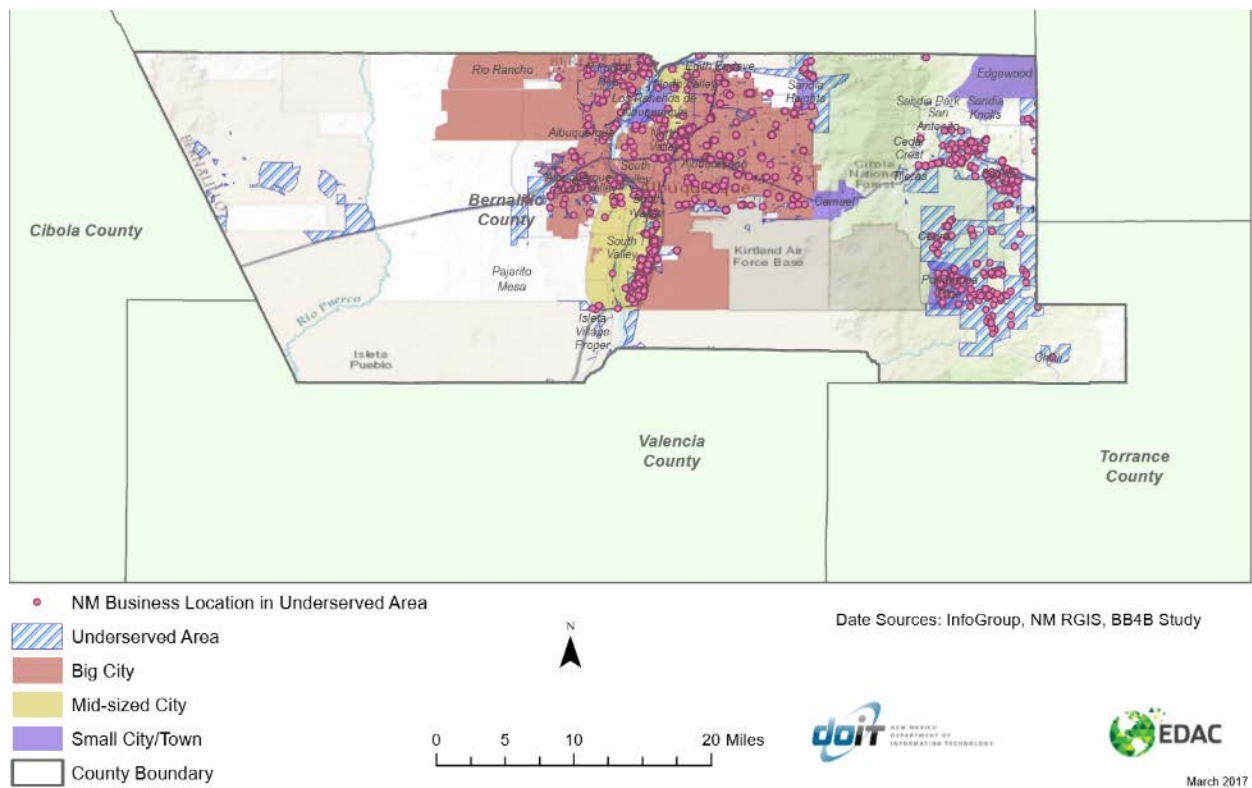

Figure 31: Underserved Business Locations in Bernalillo County

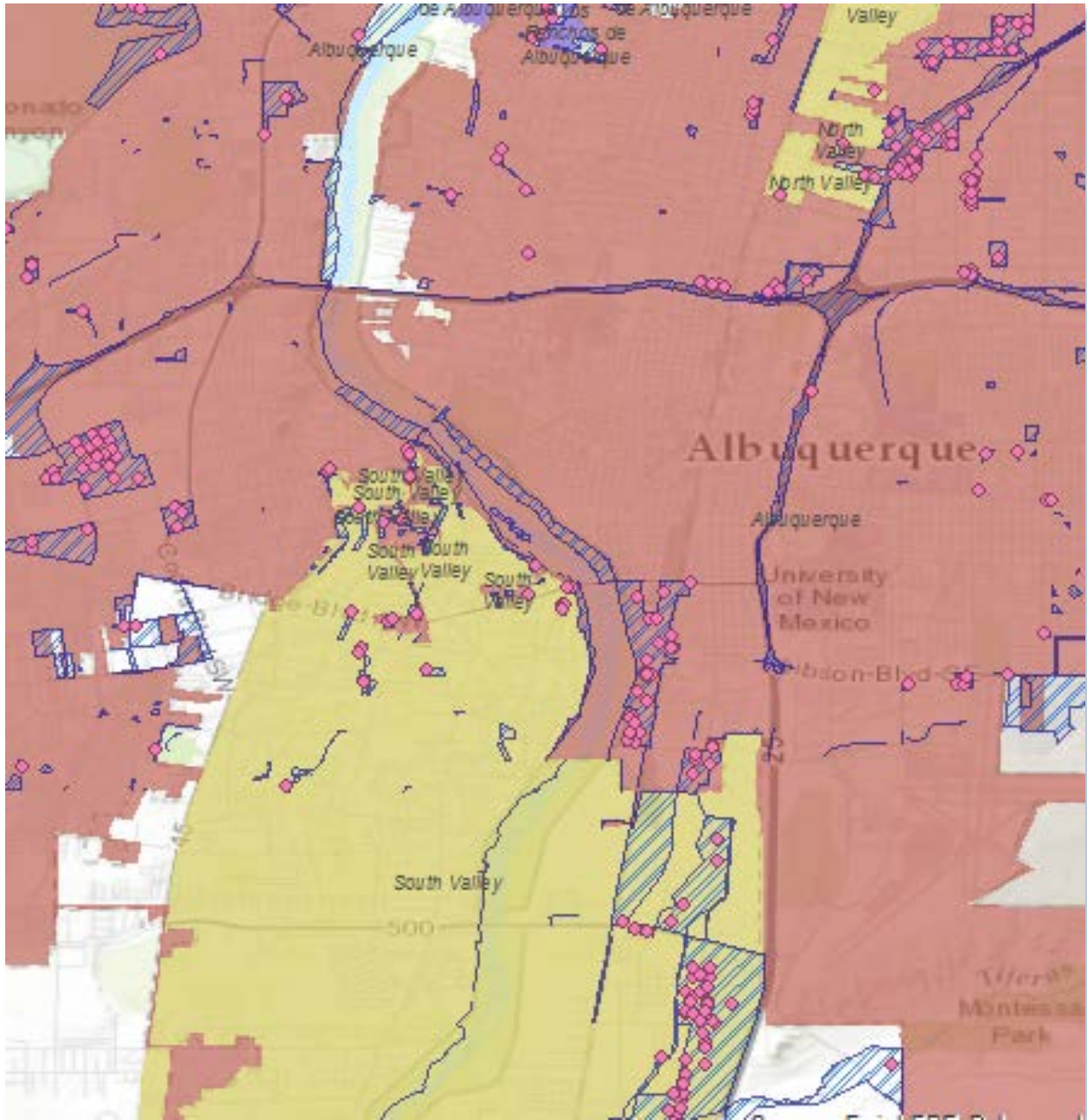

Figure 32: Underserved Businesses in Albuquerque (Enlarged to Illustrate Built-Up Area)

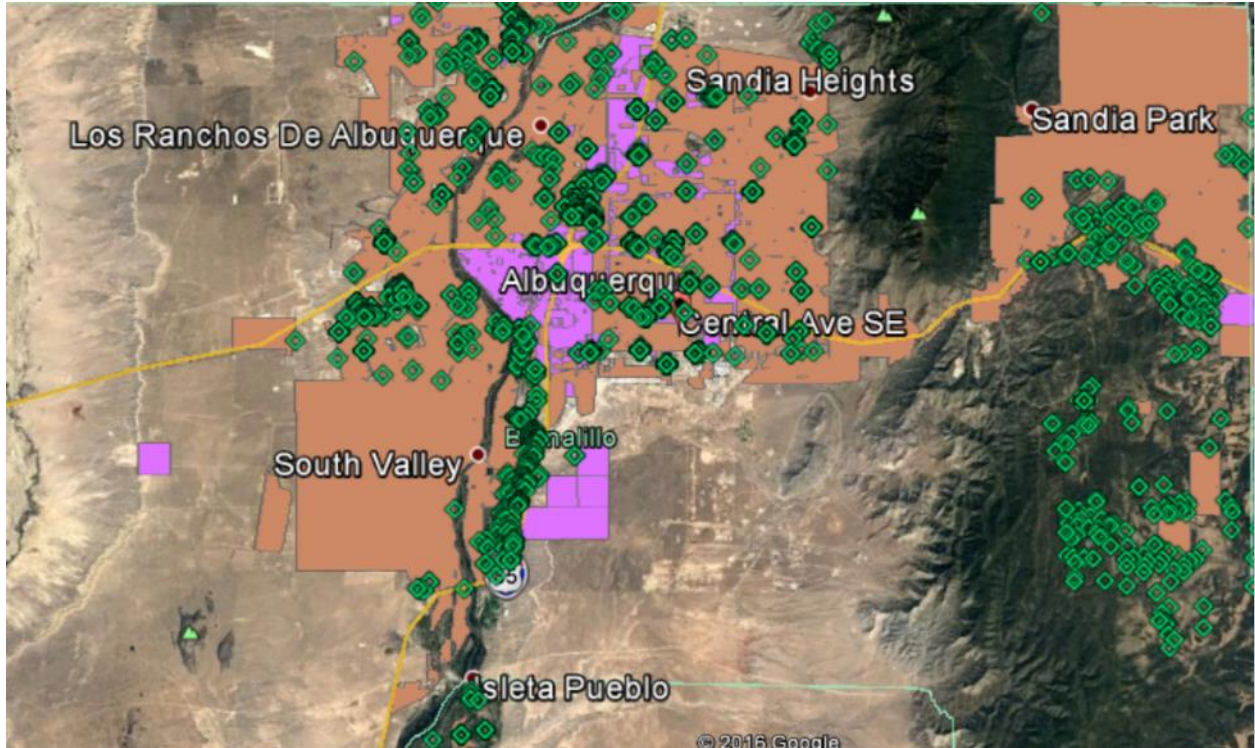

Figure 33: Cable (Brown) and Fiber (Pink) Availability Near Underserved Business Locations in Bernalillo County

Based on a review of the maps, CTC estimates that approximately 45 percent of these businesses lie within commercial corridor areas; 35 percent of them in outlying areas and the rest in smaller cities or remote areas. The businesses in the remote areas are primarily located in the rugged eastern part of the county as depicted in Figure 34. These locations need to be analyzed on a case-by-case basis as they do not appear to have upgradable CATV and require fiber construction across rugged terrain that presents a significant deployment challenge. Wireless broadband options may be the best fit in these cases.

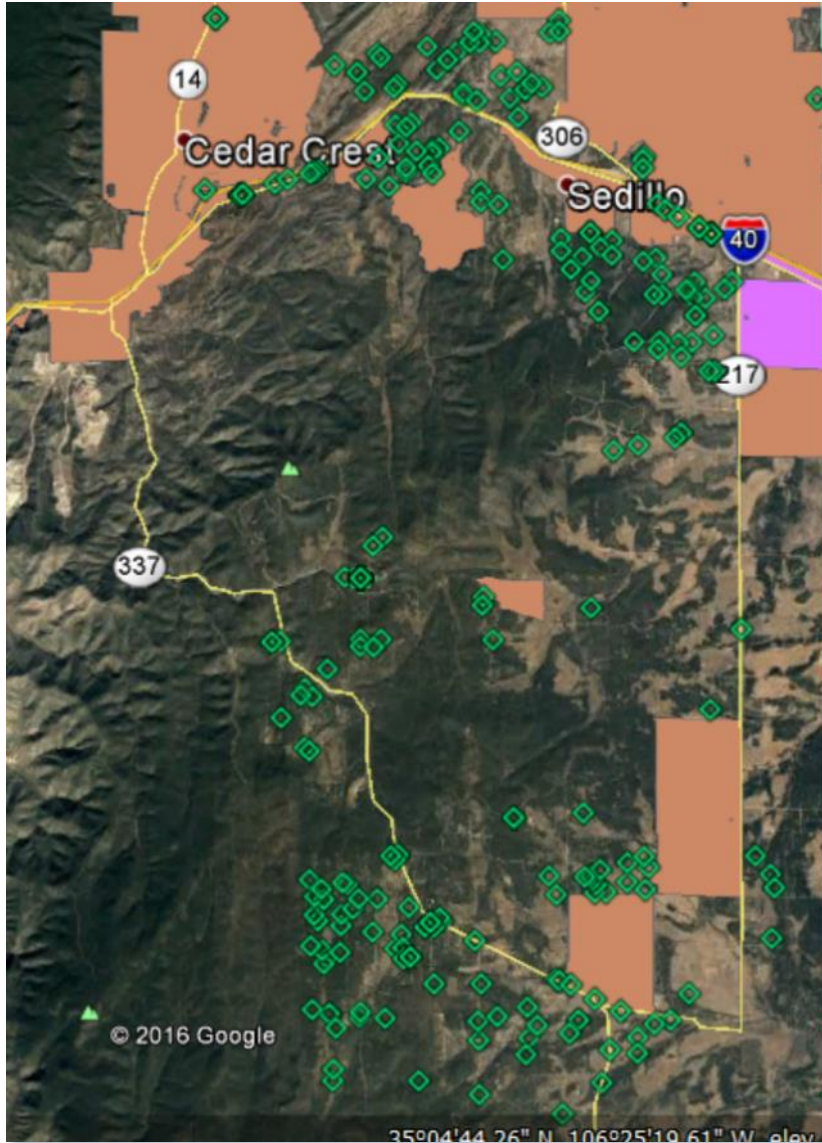

Figure 34: Underserved Businesses in Remote Areas

CTC obtained the cost per business for each type of area from the analysis in the above sections. CTC used high-end estimates for the costs to upgrade to the outlying areas as this is feasible and future proof. In the smaller city areas, CTC used the low-end costs (with lower data speeds).

A network expansion and upgrade deployment would be over \$9.4 million, inclusive of anticipated outside plant construction (labor, materials, engineering, equipment shelters). The average cost per business in this county comes out to be approximately \$3,300. CTC assumed that counties with a similar mix of underserved areas would have a cost per business in line with what is seen in Bernalillo County.

Table 3 summarizes the total estimated costs for upgrading to broadband service, broken down for the three types of areas used in the model. CTC obtained the cost per business for each type of area from the analysis in the above sections. CTC used high-end estimates for the costs to upgrade to the outlying areas

as this is feasible and future proof. In the smaller city areas, CTC used the low-end costs (with lower data speeds).

A network expansion and upgrade deployment would be over \$9.4 million, inclusive of anticipated outside plant construction (labor, materials, engineering, equipment shelters). The average cost per business in this county comes out to be approximately \$3,300. CTC assumed that counties with a similar mix of underserved areas would have a cost per business in line with what is seen in Bernalillo County.

Table 3: Estimated Costs for Network Expansion to Underserved Businesses in Bernalillo County

Area Description	Number of Businesses	Cost per Business by Area	Totals
Commercial corridors	1,284	\$2,000	\$2,567,700
Outlying areas	1,141	\$5,500	\$6,276,600
Small cities	285	\$500	\$142,500
Remote	143	Case-by-case	-
Total			More than \$8,986,800

Network Expansion Cost Estimates: Underserved Businesses in Socorro County

Socorro County has 497 business locations that are underserved. Figure 35 shows the distribution of these businesses within the county (indicated with green dots) and the availability of cable or fiber networks relative to the locations of the businesses. As depicted in this figure, there is no cable or fiber near the business locations in the county.



Figure 35: Underserved Business Locations in Socorro County

CTC conducted a high-level cost estimation to expand broadband connectivity to these businesses from the existing networks like was done for Bernalillo County. Actual costs may vary due to several local factors and the design and associated costs for construction will vary with the unique physical layout of the service area.

Most of the business in the county have DSL service with sufficient density to warrant an upgrade to VDSL at a cost of approximately \$2,800 per passing (derived from the above methodology). Some locations need to be analyzed on a case-by-case basis to see if upgradable CATV or wireless broadband options may be a better fit. The cost to provide VDSL service to over 90 percent of the business locations in the county would be approximately \$1.33 million.

Statewide Broadband Network Expansion Cost Estimates to Underserved Businesses

To develop a high-level statewide cost estimate for upgrading the underserved business to broadband, CTC extrapolated the above methodology to all the counties. The analysis was based on both a review of maps and the gap analysis. Extensive field surveys are further required to determine costs with greater accuracy.

The high-level estimate for the total cost of cable, fiber or enhanced DSL based broadband expansion to underserved businesses is approximately \$42 million (without including some remote business locations). In this analysis, around 340 locations were considered too remote for wired expansion and not included in the estimate. Additionally, approximately 125 locations appeared to be suited for the low-end option of upgrading CATV but further field surveys are needed to ascertain the presence of CATV. Table 4 provides the cost breakdown for each county.

Table 4: Broadband Upgrades Cost to Underserved Business by County

Name of County (in descending order of population density)	Number of underserved businesses	Number of underserved businesses in remote locations (not included in expansion costs)	Broadband expansion cost
Bernalillo	2853	143	\$9,414,900
Los Alamos	14		\$46,200
Santa Fe	1298		\$4,283,400
Valencia	274		\$904,200
Dona Ana	1219		\$4,022,700
Sandoval	445		\$1,468,500
Curry	122		\$402,600
San Juan	969		\$3,197,700
Lea	642		\$2,487,750
Taos	628		\$1,413,000
McKinley	477	24	\$1,550,250
Eddy	68	3	\$149,600
Chaves	22		\$86,900
Otero	294	15	\$808,500
Luna	258		\$322,500
Roosevelt	87		\$226,200
Grant	123		\$467,400
Rio Arriba	777	39	\$369,075
San Miguel	881		\$3,612,100
Cibola	792	40	\$376,200
Torrance	467		\$1,284,250
Lincoln	28	1	\$55,300
Colfax	618	62	\$1,668,600
Quay	229		\$853,025
Sierra	17		\$21,250
Socorro	497		\$1,334,445
Mora	64	13	\$25,600
Guadalupe	120		\$546,000
Hidalgo	198		\$128,700
Union	13		\$37,700
De Baca	2		\$5,600
Catron	93		\$260,400
Harding	3		\$1,500
Total	14,592	340	\$41,832,045

Chapter 4: Analysis of Databases, Business Survey and Provider Discussions

CTC conducted an analysis of the Infogroup database, performed a survey of broadband use and needs of New Mexico businesses, and held discussions with New Mexico service providers.

Infogroup Database Review

The database provides a broad range of demographic information about the businesses, but CTC notes that the database is entirely self-reported and, based on field inspection and map review, leaves out some small businesses.

CTC also found that most of the database information was not applicable to a broadband study, but the telecommunications expenses listings provided some insight into the priority and need for broadband.¹⁷

CTC found a commonality among the type of business and the telecommunications expenses. CTC performed a sample survey of the businesses in Socorro and found that the five categories of the expenses mapped approximately to different business sectors—with an indication that high-tech/aerospace and banking finance are at the high end:

- Category 1: Telecommunications expenses from \$50,000 to \$500,000¹⁸
 - Two businesses: Aerojet General and ATK Advanced Weapons
- Category 2: Telecommunications expenses from \$20,000 to \$50,000
 - 16 businesses such as Walmart, Smiths Loans, credit union, banks etc.
- Category 3: Telecommunications expenses from \$5,000 to \$20,000
 - 40 businesses such as restaurants, hotels, insurance office, vet clinic etc.
- Category 4: Telecommunications expenses from \$2,000 to \$5,000
 - 46 businesses such as car parts, mechanics, art galleries, etc.
- Category 5: Telecommunications expenses up to \$ 2,000
 - 69 businesses that were miscellaneous small retail stores.

Review of Survey Data

Working with NM OBGI, CTC developed a business survey to determine broadband usage, costs, and pain points in broadband use (Appendix D). The survey results were obtained from 30+ businesses with the majority indicating that broadband was critically important to their success and that they were unsatisfied with their current service. High costs, slow speeds and drops in service were pain points with equal significance. Respondents commented that broadband should be an economic development priority. One respondent indicated that it deployed its own fiber on power poles in order to get providers to collocate in its facility, thereby potentially improving service.

Discussions with Service Providers

CTC conducted a briefing for the State's ISPs and had a series of one-on-one meetings with individual service providers, the New Mexico Carrier Exchange Group (NMECG), and the Arizona-New Mexico Cable

Communications Association. The purpose of the meetings was to verify the State's broadband map, to understand what broadband services are offered to businesses, and to jointly develop strategies for improving broadband to businesses.

Briefing to Service Providers

On January 18, CTC presented by WebEx and teleconference a briefing and discussion with service providers. The briefing introduced the project and solicited feedback on how to best conduct the one-on-one meetings. Further details on the briefing are provided in Appendix A. The presentation to the providers is provided in Appendix B.

Thereafter, CTC conducted one-on-one meetings with several service providers. Some common themes emerged during CTC's discussions with providers which may highlight specific actions the State may take to encourage further broadband development.

Common Themes

Providers indicated that access to utility poles and the rights-of-way (ROW) were potential barriers to broadband expansion. Utility pole access issues vary by pole owner, available pole capacity, and pole age or state of repair. For instance, Las Vegas was identified as an area where the cost of aerial construction is increased significantly by pole congestion and the amount of make ready required for new infrastructure.

While access to the ROW within municipalities is generally handled by a franchise agreement with carriers, ROW access for long-haul fiber between municipalities was a potential issue. The carriers recognize the rights of different regions to set their own pricing and requirements, but point out that in some cases, the costs are so high that it was cheaper to circumvent some areas or not cost-effective to build at all. Some carriers suggested that while the fees collected by these regions may benefit the community, the increased costs would hamper long-term broadband deployment and economic development initiatives.

Similarly, some carriers noted that they had experienced inconsistency among different government departments and different levels of government. Inconsistent costs and requirements, as well as varying levels of enthusiasm for and facilitation of broadband expansion initiatives can prove to be an obstacle for carriers who must work with several different government groups to complete a project. To increase the effectiveness of its broadband initiatives, the State may need to work internally toward education, communication, consistency, and buy-in among internal stakeholders.

Providers indicated that they could provide more fiber and better DSL if they had a large-scale anchor customer like a school district or health care institution. Some providers have built networks anticipating serving a school district, which instead built private networks. It would be advantageous to use connections to CAIs as a means of having infrastructure in place to provide advanced services to businesses and homes. There are also lot of possibilities with copper networks, including Multiprotocol-Layer-Switching (MPLS) and Ethernet service available with both 2-wire and 4-wire technology.

The providers were also interested in having groups of customers forming a consortium or single buying block (such as a combined group RFP, discussed below) with a commitment to offset the cost of buildout or a substantial term commitment. Most providers have an enterprise/small business group specialized in servicing these types of customers.

The providers also pointed out that several apparent coverage gaps existed on the New Mexico Broadband Map due to outdated or incomplete information. As next steps, some providers agreed to provide the State DoIT with updated service area and coverage maps, information on which census blocks they would build under using CAF II funding and set up further discussions with State DoIT and CTC.

Chapter 5: Recommended Implementation Strategies

Broadband continues to be a critical driver of economic development. Over the past few years, the rise of digital economies based on online technologies and platforms has underscored its essential role.

The findings from a 2016 report on internet connectivity and utilization¹⁹ capture the growing trend for businesses nationally: namely, the need for reliable broadband service to support economic viability and ensure successful outcomes. Similar studies of global economic development reinforce this finding; the Broadband Commission for Sustainable Development concluded:

“A 10% increase in broadband penetration is likely to have a positive impact, and could raise economic growth by between 0.25% – 1.4%.”²⁰

By lowering operating costs, improving the speed and efficiency of transactions, increasing sales volume and reducing advertising expenses; the use of online platforms and digital tools allows businesses to markedly improve their bottom line.²¹ In addition, recent data shows that broadband speed correlates directly with business revenue, indicating the value of increased internet speed for accelerating sales and market expansion.²²

Just as broadband offers businesses clear advantages, a lack of broadband can create barriers to success for business enterprises. Without a broadband connection, business websites cannot showcase products effectively. Websites operating without broadband will load and process information slowly, potentially causing customers to abandon transactions and sales.²³ Lack of broadband service can also prevent businesses from ordering products online or collaborating on creative or marketing campaigns. Without broadband, a business will be less efficient and less effective, and will project an image of an enterprise that is becoming obsolete.

Broadband service can be the difference between success and failure for businesses. CTC presents the following recommendations for state and local leadership in developing broadband access and use in New Mexico.

Establish Permanent Funding for the State Broadband Office

It is widely recognized among broadband planners and economic development professionals that state offices of broadband planning are an important differentiator for rural broadband expansion. Even in the absence of state funding to build new broadband networks, a broadband office enables the state to coordinate and plan among public and private entities, including for purposes of taking advantage of new federal grant opportunities.

States that have consistently supported their broadband offices have found the investments to be worthwhile in a range of different ways based on local needs. For example, the North Carolina state broadband entity has been instrumental in working with the private sector to improve broadband to rural hospitals. The Utah broadband office has done the same in the education sector. The Kentucky office was successful not only in stimulating local government to develop public–private partnerships in broadband but also in attracting prominent broadband conferences to the state and raising the state’s profile as a leader and visionary in this area.

For these reasons—and to build on New Mexico’s successful investment to date—the State should consider legislation that would provide ongoing funding for the Office of Broadband & Geospatial Initiatives (OBGI). Such stable funding would allow the office to continue its efforts toward broadband opportunity without the frequent uncertainty regarding future appropriations.

In particular, secure funding for OBGI would enable the office to continue two important tactical approaches—its community outreach activities (a key element in determining need and promoting broadband adoption) and its efforts to keep the NMBBP map up-to-date (a critical task for developing data to guide future investment).

Secure funding for OBGI would also support the office’s important strategic role—perhaps best illustrated by its potential to engage with the FCC’s Connect America Fund program. If authorized and funded, the OBGI could be a critically important conduit to work with private carriers to determine their CAF buildout and service plans, and then to verify that they are delivering what they promised the federal government.

This could be a particularly important function for the State to build if the FCC is less than vigilant in verifying compliance and enforcing its own rules for the public broadband funding. State vigilance in this area—ensuring that carrier promises are actually fulfilled—could be incredibly important for New Mexico consumers and small businesses.

Similarly, over time, OBGI could play a critically important role in encouraging providers to apply for federal funds and, where offered, to accept the funding in the best interest of the State of New Mexico. For example, while CenturyLink accepted CAF Phase II funding for New Mexico, Windstream declined funding for the state—even while accepting funding in 17 other states. Windstream’s stated reason for declining the funds was that the FCC did not allocate sufficient funds to for the company to meet its obligations in New Mexico.

As a result, Windstream’s service areas in New Mexico are in limbo. The FCC has stated that the areas where the incumbents declined CAF Phase II funding, such as the Windstream territory in New Mexico, will be reverse-auctioned. The FCC has not yet announced a date for the auction—but that process, when it commences, would be an opportunity for competitive providers, localities, electric utilities, and others to bid for those funds to serve those census blocks.

In a separate CAF offering for smaller, “rate of return” providers, Plateau and a number of other carriers declined CAF funding, choosing instead to remain in the FCC’s legacy program for high-cost services areas.

Through OBGI, the State would be in a position to work with companies such as Windstream and Plateau to advocate for New Mexico’s interests with regard to federal funding in Washington. At the same time, OBGI would be in a unique position to work with other State agencies and local communities to identify ways to improve the economics for companies like Windstream such that those companies would be willing to accept federal funds and invest accordingly in New Mexico.

Consider Public Funding for Broadband Infrastructure

In large parts of the United States, telecommunications and broadband deployment are not commercially viable absent some significant form of public funding. For this reason, the federal government and many states have long supported funds that subsidize operations in high cost areas where the private sector

cannot make a return absent the subsidy. Current federal programs, most significantly the Connect America Fund, are designed to provide an operating subsidy to telecommunications companies for such high-cost areas, but this program prioritizes residential service—not services to businesses. Regardless of the mechanism, some form of subsidy is likely to be required now or in the future to address the needs of New Mexico’s small businesses for adequate broadband.

Absent public funding, there do exist a range of mechanisms that the state and others can use to create an environment that is maximized (though not, of course, guaranteed) to attract investment from providers into the underserved areas. These mechanisms represent best practices and will improve conditions for private investment. These recommended implementation strategies are described below.

Use Joint Purchasing Strategies to Reduce Businesses’ Broadband Costs

A purchasing strategy that leverages the collective buying power of underserved businesses within a certain underserved region presents an attractive customer for commercial service providers. In return, the businesses would get better pricing and faster availability of services.

This model has the potential to get greater attention and customer services from providers than a standalone small business customer.

Description of the Joint Purchasing Model

New Mexico businesses can be encouraged to aggregate their buying power to improve the attractiveness to private providers of serving them with broadband. Using this strategy, multiple businesses in proximity to each other could jointly solicit and contract for small business grade services, or any other broadband communications services they are seeking (such as Metro Ethernet).

The businesses would cooperate to develop an RFP and select a service provider. Significant leadership and organization are necessary to implement aggregated buying, including convincing all the businesses’ stakeholders to participate. In CTC’s view and experience, the benefit of service offsets the challenges and burdens.

The State could assist by publicizing the underserved areas, preparing a template RFP, educating the business community, and introducing the concept to the service provider community. Further, the State could assist with funding. The RFP should be succinct and offer flexibility on the service model to be proposed.

Benefits of the Joint Purchasing Model

The benefits to the joint pursuing this model include:

- Lower per-unit pricing across the services and shared upfront, non-recurring charges
- Potential for increased investment and improved services by private sector providers

Greater purchasing power can deliver better pricing because bidders offer lower per-unit service costs to secure the higher-volume business opportunity. When combined, a group of small businesses presents a substantial customer for a provider. It also results in greater market leverage. In addition, the one-time installation fees are likely to be lower than when individual businesses request new services due to economies of scale in construction costs.

The development of new infrastructure would serve not only the businesses involved in the purchasing, but also potentially other users in the areas where it is built. It provides a means of extending service over time to other potential customers. At the same time, the construction can have direct economic development benefits, as well as the long-term indirect benefits that flow from the new communications services.

CenturyLink and Comcast, the dominant Incumbent Local Exchange Carriers (ILEC) in New Mexico, would be potential participants. During the one-on-one discussions, CenturyLink, Comcast, and Plateau had all expressed interest in pursuing this type of collective purchasing opportunity.

A group RFP could include a commitment to offset build costs and increased overall term commitment. The terms of the RFP could be developed in such a manner that it presents greater interest to the provider and minimizes risk to any individual business should they have to discontinue service.

Ideally, the buying group would be as large as possible and would include both small and large businesses—thus enabling the smaller businesses to benefit from higher-end services and the buying power of the larger business.

Leverage Purchasing Power of Community Anchor Institutions

In a similar vein, the buying power of the public sector can also be utilized to incent new deployment. CTC recommends that the State consider leveraging its procurement process for broadband services to encourage deployment of advanced services to businesses. This could include adding points in the procurement process for service providers who demonstrate how businesses and residences in proximity to a community anchor institution (CAI) will receive better broadband and lower prices if they are selected to serve that CAI.

During the discussions with CenturyLink and Comcast, the companies expressed that a school district, large government facility, or health care facility often becomes an anchor user of broadband in an area. CenturyLink builds fiber to the facility and locates electronics in the facility. This reduces the cost of providing fiber services and more enhanced DSL services to the surrounding area.

Consider “Dig-Once” Policies to Coordinate Excavation Projects and Decrease Broadband Deployment Costs

CTC recommends that the State identify planned excavation projects and create a public database of projects, project descriptions, project managers and construction dates so that DoIT OBGI and broadband deployers can identify opportunities for broadband deployment. This can be part of a “Dig-Once” policy, as encouraged in the National Broadband Plan, that can enable service providers to more cost-effectively construct fiber optics and other broadband infrastructure at reduced cost while a trench is open or a road is under construction. This can be especially useful where a project crosses a bridge, interchange, or other location where broadband construction is expensive; where a project stretches a long distance; or alongside a major corridor. Dig once policies may also facilitate the construction of spare conduit capacity where multiple service providers or entities may require infrastructure.

Recent legislation²⁴ that enables the placement of conduit when trenches are dug can be expanded to

include projects driven by local governments or other excavators. State and local governments may also set aside funding to facilitate this further such as for the placement of spare conduit.

Standardize and Simplify the Process for Accessing the PROW

Certain processes associated with permitting and accessing the public right-of-way (PROW) may hinder the rate of broadband expansion in the State. A provider typically must obtain access from multiple entities such as state, county, and tribal agencies to access public or private land along their proposed construction routes. Entities may have very different policies and fees associated with this access.

Without statewide standardized implementation processes regarding PROW access, the process can become unduly cumbersome. The PROW approval process could be made into a State statute that could require local agencies to follow State standards. It is advisable to engage the industry to during the development of these standards.

The economic development benefits of simplifying broadband expansion through standardization and charging reasonable PROW fees also must be highlighted to all levels of the public, state, and local leadership and relevant private businesses and non-profit groups. Building an outreach and awareness campaign that promotes the understanding of the central role of broadband in economic development, business growth, and rural sustainability, will help in this regard. An exchange of infrastructure may also be considered a form of payment in accessing the PROW as seen in other municipalities nationwide.

Promote a Collaborative Planning and Implementation Framework

Greater collaboration with state initiatives such as Broadband for Libraries (BB4L) and Broadband for Health (BB4H) and federal initiatives reduces redundancy and the costs associated with implementation strategies.

BB4L is actively engaged with the State Library through the newly formed New Mexico Libraries Transform (NMLT) initiative. The NMLT has convened a Broadband/E-rate Funding Task Force that includes representatives from libraries, K-12 schools, tribes, and higher education. The Department of Information Technology (DoIT) Office of Broadband & Geospatial Initiatives (OBGI) is participating on this Task Force as a Technical Advisor. The mission of the Task Force is to report on the current state of broadband in New Mexico for libraries of all types; perform an environmental scan of successful solutions in other states to improve broadband for libraries; and make recommendations for potential implementation in New Mexico, including methods for encouraging libraries to participate in the E-Rate program.

BB4H through the New Mexico Telehealth Alliance (NMTHA) has been promoting the use of technology in the delivery of medical care. They assist in the evaluation of needs, selection of technology, deployment, and incorporation into work flow of healthcare providers for the delivery of clinical services and training to healthcare workers, particularly in rural areas. The NMTHA is currently involved in the management of the Southwest Telehealth Access Grid which is a consortium that represents several healthcare organizations in their application for connectivity subsidies from the FCC Healthcare Connect Fund.

A mechanism to provide ongoing updates to the public on the progress made in service availability (particularly resulting from government initiatives) would help in broadband adoption statewide. It

would also improve transparency and foster competition amongst providers.

The OBGI has the capability to assist in the assessment of the level of service, network planning, infrastructure mapping, wireless propagation analysis, regional analytics reporting, and identifying network performance issues. The NMBB Program's speed test is a tool that helps identify areas within New Mexico which have inadequate broadband service through data gathered from the public.²⁵ As underserved areas receive service enhancements, the NMBB Program could continue to provide updates on new service availability via the online mapping platform²⁶ and notifications to business. Continued support of initiatives that disseminate service availability information is paramount.

Chapter 6: Case Studies—Analysis of Statewide Projects for Business Broadband

The following case studies illustrate the approaches taken by four entities, Vallejo and Culver City in California, Westminster, Maryland and the State of Connecticut to expand broadband availability for business customers. These approaches both entailed long-term strategic planning and highly-focused public investment. They sought to maximize the use of existing assets, minimize risk, and create the greatest possible impact on local economic development through improved access to business-grade broadband services.²⁷

Case Study: Culver City, California

In 2013, Culver City commissioned a detailed study of the potential for fiber network deployment to boost economic development efforts. The city's objectives for the project centered on five large tracts of buildings in this urban center near Hollywood and the film industry. The overarching goal was to create the type of robust fiber connectivity options that would both attract and retain technology-centric businesses to these buildings.

Background

For the type of businesses that Culver City hoped to attract—small companies, often start-ups, and likely to be in the film and supporting industries because of the city's proximity to the Hollywood studios—the availability, affordability, and reliability of high-capacity broadband connectivity is essential.

Culver City estimated that more than 80 percent of the buildings in the target tracts would have multiple tenants, which indicated that the market for broadband services in the tracts would comprise mostly small businesses. Despite the existing service options at some of those buildings, there were still connectivity issues in those areas as a whole—especially for small technology-centric businesses.

First, broadband availability was not ubiquitous (e.g., every building, every service). Second, where service was available, the cost of getting a new “drop” connection to an office or other facility was often excessive, even for a large business. And third, the types of available services were not well-suited to small businesses. Each tract had a range of available connectivity options, including services such as dark fiber, cable modem, DSL, Metro Ethernet, and MPLS (Multiprotocol Label Switching). But most of these services were tailored to either casual users (e.g., cable modem or DSL, which do not meet business performance needs) or large users (e.g., Metro Ethernet or MPLS, which meet business requirements but with unaffordable monthly costs that would represent a substantial portion of many business' ongoing operating costs).

Taken together, these issues drove Culver City's goal of expanding its communications infrastructure in these tracts to advance the availability, affordability, and reliability of retail connectivity services tailored to the technology-centric small business market in the identified tracts.

Planning

Culver City's proposed fiber deployment plan comprised five phases:

1. Implementing a redundant open-access fiber backbone and an access point in each tract as the foundation for future connectivity. The proposed backbone would leverage the city's existing conduit, and was designed so that each tract could be added as needed once the backbone was completed.
2. Deploying fiber laterals in each tract to enable cost-effective connectivity to individual businesses. A key in the lateral design was to ensure that "taps" (where a fiber drop from a building connects to the lateral fiber) were located so that the drop costs were minimized.
3. Extending fiber to health care and educational facilities to create additional community benefits.
4. Extending fiber to additional office buildings and multiple-dwelling units near the backbone and lateral fiber routes to increase revenue and expand the benefits of the fiber availability.
5. Identifying private partners to offer services to the businesses over the open access fiber.

Culver City's next steps included:

1. Obtaining a connection into the carrier hotel (One Wilshire) in Los Angeles
2. Obtaining network operations center (NOC) monitoring and support
3. Obtaining a contract for fiber maintenance
4. Conducting focus group or other discussions with potential businesses and property owners in the identified tracts to help refine services (performance and price)
5. Reviewing proposed business models and finance plans with City legal counsel
6. Preparing a detailed fiber and network design that could be used to prepare bid and other procurement documents
7. Exploring with building owners the possibility of including a connection services contract with the owners' facility leases
8. Refining proposed service offerings, pricing, and performance attributes as discussions with potential ISPs unfolded.

Execution

The city created a "Municipal Fiber Network Enterprise Fund" in November 2015²⁸ and broke ground on fiber construction in August 2016. According to the city:

"The City will expand its existing fiber network to install approximately 21 route miles of fiber for a redundant network backbone. The network design includes three geographical network rings that are all interconnected and will also connect to the telecommunications hubs at One Wilshire and in El Segundo. The City's goal for extending this network is to enhance economic development by facilitating the delivery of high speed internet access for Culver City businesses located within the target areas, as well as enhancing broadband connectivity to the Culver City Unified School District. The City will install an open access network, where it is envisioned that any ISP will have the opportunity to utilize the City's fiber infrastructure to service the business community. This will result in the business community having more

service options when selecting a broadband provider.”²⁹

Case Study: Vallejo, California

The city of Vallejo developed a master plan to analyze the feasibility and guide the long-term planning, budgeting, and implementation of a city-owned fiber network.

Background

Vallejo sought to comprehensively assess its options, evaluate the advantages and drawbacks of potential business models, identify funding requirements (to be assumed by a combination of public and/or private entities), and lay the groundwork for a phased implementation that would enable on-demand build-out without incurring any debt. The city’s commitment to digital equity also guided its decision-making process.

Vallejo had considerable fiber and conduit assets in place, so the master planning capitalized on that infrastructure.

Planning

The city considered a range of business and operational models that might enable it to meet its goals while effectively reflecting its desired operational role, risk tolerance, and preference for a phased implementation plan with no debt. The two primary options it evaluated were a city-owned network and a public–private partnership.

Preliminary evaluation of the costs to construct and operate a city-owned network assumed that the city would form a standalone enterprise that would operate and maintain the network, and would sell 1 Gbps and direct internet access (DIA) services to 17 city and institutional sites.

As an alternative approach, the city explored the potential for a well-negotiated partnership to reduce the city’s capital requirements and limit its risk. However, a partnership would also likely reduce the city’s control over deployment and service decisions—and would potentially limit the economic development impact of the infrastructure expansion.

Vallejo issued an RFP in September 2016 to secure a dark fiber connection to an internet point of presence (POP)³⁰—like the way in which Culver City sought a connection to the One Wilshire carrier hotel.

The city updated its Dig-Once ordinances to create a mechanism to track city capital improvement projects and third-party excavation projects and identify opportunities for coordination. This update is designed to reduce the number of separate excavation projects and to increase the inventory of conduit for broadband.

The city is reportedly still weighing its options in terms of a business model to pursue.

Case Study: Westminster, Maryland

The city of Westminster, located in Carrol County in Maryland, is a bedroom community of both Baltimore and Washington, D.C. where 60 percent of the working population leaves in the morning to work elsewhere. The area has no major highways and thus, from an economic development perspective, has limited options for creating new jobs. Incumbents have also traditionally underserved the area with

broadband.

Background

The city began an initiative 14 years ago to bring better fiber connectivity to community anchor institutions through a middle mile fiber network. In 2010, the State of Maryland received a large award from the federal government to deploy a regional fiber network called the Inter-County Broadband Network (ICBN) that included infrastructure in Westminster.³¹

Westminster saw an opportunity to expand the last mile of the network to serve residents. At the time, though, it did not have any clear paths to accomplish this goal. As the community evaluated its options, it became clear that the fiber infrastructure itself was the city's most significant asset. The challenge then was to determine what part of the network implementation and operations could be the city's responsibility and what part a private sector partner would handle.

The hybrid model that made the most sense required the city to build, own, and maintain dark fiber, and to look to partners that would light the fiber, deliver service, and handle the customer relationships with residents and businesses. The model would keep the city out of network operations, where a considerable amount of the risk lies in terms of managing technological and customer service aspects of the network.

Planning

The city would construct fiber within particular areas of the city, and the private partner would provide advanced broadband services to connected homes and businesses using the fiber. The private partner would be responsible for interconnecting outside networks such as the Internet to the fiber. The private partner would provide electronics to "light" the fiber and carry services over the fiber, will interface with the customer, and will be responsible for maintaining the fiber.

The city developed two pilot projects involving a residential area and a business area. Both pilot areas were in proximity to the county's Carroll County Public Network (CCPN) fiber to maximize use of existing resources. The business pilot project area encompassed the Westminster Technology Park³², the Carroll County Air Business Center, and vicinity—chosen for the area's size, density of businesses, proximity to CCPN fiber, and identification by the city as a prime economic development zone that would both benefit from fiber connectivity and help the city meet their broadband policy goals. It addressed a longtime deficiency in broadband access in the technology park as the area was outside of the cable franchise coverage.

Execution

The city solicited responses from potential private partners through a request for proposals (RFP). Its goal was to determine which potential partners were both interested in the project and shared the city's vision.

The city eventually selected Ting Internet, then an upstart ISP with a strong track record of customer service as a mobile operator. Ting shared Westminster's vision of a true public-private partnership and of maintaining an open access network. Ting had committed that within two years it will open its operations up to competitors and make available wholesale services that other ISPs can then resell to consumers.

Under the terms of the partnership, the city builds and finance all of the fiber (including drops to customers' premises) through a bond offering. Ting leases fiber with a two-tiered lease payment. One

monthly fee is based on the number of premises the fiber passes; the second fee is based on the number of subscribers Ting enrolls.

What is so innovative about the Westminster model is how the risk profile is shared between the city and Ting. The city bonds and take on the risk around the outside plant infrastructure, but the payment mechanism negotiated between the city and Ting ensures that Ting is truly invested in the network's success.

As of the writing of this report, the two pilot areas have been built. Both are served by Ting and the project was deemed successful. The city is currently in the process of building out the rest of the city, and construction has started on the early phases of the citywide project. Ting will be providing service for the rest of the city.

Case Study: Connecticut

Like most of New England, Connecticut and its cities have not yet experienced extensive private sector investment in the most robust, most future-proof communications infrastructure. This is true even in Hartford, the State capital, a major city in the State, and a densely-populated community.

Background

While there are many parts of Connecticut that are reasonably well-served today by current providers, some parts of the state are unable to access high-speed Internet at affordable prices. Businesses only have access to lower-speed DSL; in some commercial areas and in certain rural towns, particularly those that were never served by cable television.³³

According to officials of the City of Hartford, the city receives frequent complaints, particularly from businesses, about challenges with accessing affordable broadband services. On parts of Main Street close to downtown Hartford, only inadequate DSL service is available on one side of the street. Businesses in several areas can access only unreliable DSL services that are insufficient to meet their business needs.³⁴ Local officials in some rural areas report similar complaints, and that some businesses and institutions struggle to get adequate service to meet their needs.³⁵

Affordability is obviously a crucial aspect of enabling Connecticut citizens and businesses to enjoy broadband speeds enabled by fiber networks. The range of serious broadband challenges in the State, include:

- Maximum speeds are often far less than what businesses need for their current operations
- There are limited or no affordable competitive options for broadband services for businesses in urban areas
- Businesses' growing needs for broadband will further exceed the available broadband services
- Businesses face long delays in obtaining services, or are unable to obtain service even when infrastructure is relatively nearby
- Small and medium-sized businesses are being constrained by lack of broadband infrastructure and, where infrastructure is available, lack of competitive options (leading to higher prices and limited

service).

Comparison with Recommended Strategies for the BB4B Study

The cities of Culver City, Hartford, Westminster and Vallejo and the state of Connecticut identified key areas that were underserved for broadband to businesses. Efforts were made to encourage network upgrades at targeted areas. Key city/state assets and infrastructure were leveraged to keep costs down and to remove unnecessary potential delays. The approach also involved the inclusions of CAIs and identifying leasable facilities. Further, steps were taken to assess the costs associated with enhancing broadband services to determine the best strategy to pursue and inform procurement processes. The approach also intended to view existing service providers as partners in the effort.

Appendix A: Summary of Stakeholder Engagement and Methodology

Together with OBGi and EDAC/UNM, CTC held outreach sessions with various broadband service providers in the state.

OBGi, EDAC/UNM, and CTC hosted a meeting with service providers on January 18, 2017 to discuss the BB4B study and the broadband coverage area maps, and to discuss the carriers' roles in improving broadband availability in the state. In addition, CTC invited service providers to submit additional data and participate in individual meetings to discuss infrastructure and services.

During the discussion, CTC shared an overview of the broadband service data collected, as well as the results of the gap analysis showing underserved areas. CTC then sought comments from the carriers about the accuracy of this data.

Cable One and Baca Valley Telephone found areas where their coverage information did not agree with the data collected by the NMBB Mapping Project; CTC is collecting data from these carriers to review and integrate into the analysis. Where possible, CTC collected information about future expansion plans which will also be integrated into the analysis. Further, CTC provided an opportunity for service providers to discuss their role in expanding broadband access to underserved areas and the technical and economic challenges in doing so.

Thereafter, one-on-one meetings were also held with three service providers. The common themes that emerged from these meetings have been provided in Chapter 4.

The following service providers participated in the meetings:

- Baca Valley Telephone
- Cable One
- CenturyLink
- Comcast
- Cyber Mesa
- Kit Carson Electric Cooperative
- Leaco
- Level3
- Plateau Telecom
- Sacred Wind Communications
- Suddenlink Communications
- TDS Telecom
- Tularosa Basin Telephone Company ("TBTC")
- Valley TeleCom Group
- WNM Communications
- Yucca Telecom

Appendix B: Broadband Service Provider Outreach Presentation

(MS PowerPoint presentation attached as a separate file.)

Appendix C: Summary of Data Sources Collected

To assess the current availability of broadband services for New Mexico businesses, CTC made use of several existing datasets.

Map Datasets

The primary datasets were the New Mexico Broadband Mapping Program³⁶ dataset which includes broadband coverage areas for each type of broadband technology and location data for community anchor institutions (CAIs) and a set of business and residential locations from Infogroup.

The New Mexico Broadband Map, managed by EDAC/UNM and NM DoIT through the Office of Broadband and Geospatial Initiatives (OBGI), “displays all wire-line and wireless broadband services available in the State of New Mexico, based on the type of technology reported in data collected from ISPs and other sources.”³⁷ Coverage data is collected from service providers and other publicly-available sources as well as crowdsourced directly from consumers.

The business and residential location data from Infogroup was used to determine how many businesses in the State are in areas currently underserved by broadband and to help classify the underserved areas.

CTC also performed desk surveys using Google Earth as well as field surveys to locate visible broadband infrastructure. This helped to assess the accuracy of the broadband coverage data from other datasets and informed the broadband deployment cost analysis.

Connect America Fund (CAF)

To avoid duplication of effort with federal funding programs, CTC also collected data from Phase II of the FCC’s Connect America Fund.³⁸ Phase II of the Connect America Fund offers annual monetary support for service providers to deploy wireline broadband and voice services to areas that are not already being served by competitive service providers offering a minimum level of service. The program makes use of three funding models: 1) the Connect America Cost Model,³⁹ 2) the Alternative Connect America Cost Model,⁴⁰ and 3) the Connect America Phase II Auction.⁴¹

The Connect America Cost Model (CAM) is a tool developed to estimate the cost to provide voice and broadband-capable network connections to all locations in the country. The model calculates the cost by census block areas, considering geographical and regional factors that would affect construction in each region. The model determines census blocks that are eligible for funding based on the estimated cost to build and then excludes census blocks where costs are too high (indicating the area might be better served by another technology) or where other qualifying services already exist. Census blocks were marked ineligible for funding if 1) a subsidized carrier is offering services of at least 3 Mbps down and 678 Kbps up; 2) a carrier, subsidized or unsubsidized, is offering services of at least 10 Mbps down and 1 Mbps up.

Any area that is not served by an unsubsidized carrier offering 10/1 Mbps but is served by a subsidized carrier will be eligible for funding under the Phase II reverse auction, even if the subsidized carrier meets or exceeds the 10/1 Mbps service threshold. Funding based on the CAM was offered to incumbent “price cap” carriers based on their existing service areas. Carriers could accept or reject offers by state, but

otherwise could not “cherry pick” census blocks within the state. The program requires annual progress reports from carriers on a state-by-state basis. Each carrier must offer service to 40 percent of their accepted areas by the third year of support and must add an additional 20 percent each year, serving 100 percent of their accepted area by the end of year six.

The Alternative Connect America Cost Model (A-CAM) is a tool developed to provide “rate-of-return” carriers like Plateau an opportunity to transition from legacy support offerings to model-based support for expanding their service areas. The process was similar to the CAM-based funding offers, but applied to the rate-of-return carrier service areas. Carriers had the option to accept or decline A-CAM funding on a state-by-state basis, or to continue to receive funding under the legacy rate-of-return agreement. Declining A-CAM funding did not mean the carriers would receive no Connect America funds—only that the carriers would continue under the legacy rate-of-return funding approach.

Finally, to address the initial census block offers that were declined by price cap and rate-of-return carrier offers, extremely high-cost census blocks, and areas that were excluded from funding because they are served by a subsidized carrier, the FCC will hold a reverse auction that will allow carriers to bid on support for the remaining areas by submitting the lowest-cost proposal.

An additional program, the Remote Areas Fund, will provide non-terrestrial broadband services to extremely high cost areas that are not served by CAF Phase II.

The FCC has identified the census block areas that are eligible for CAF funding, as well as the areas for which funding has been accepted by the carriers. CTC has incorporated these data in the analysis to identify underserved areas that will be addressed by the CAF and to highlight underserved areas that will not be addressed.

It is important to note that the CAF used its own criteria to determine which areas are eligible for funding as well as the requirements made of the carriers that accept support funds. These criteria may not match the criteria used in the BB4B study to determine which areas are underserved; the criteria have been adjusted several times over the course of CAF Phase II with the goal of the FCC getting “the most bang for its buck.”

Most notably, one of the primary criterion used by the BB4B was whether an area has fiber and/or cable internet service. CAF, while using technical criteria that may exclude certain technologies due to their performance limitations, specifically chose “technology-agnostic” requirements for its model and instead focused on performance metrics such as speed and latency.

Appendix D: BB4B Survey to Businesses

The BB4B Survey to Businesses was developed by Cirrus Consulting as part of the BB4B study. CTC and EDAC/UNM provided recommendations to Cirrus Consulting during its development.

The survey was taken by businesses in the state through an online site hosted at:

<https://www.surveymonkey.com/r/9X2TTFT>.

The survey and its results are also attached to this report in separate Adobe PDF files as Appendix D1 and D2.

Appendix E: Field Survey Findings

From January 16 to 20, 2017 and February 6 to 9, 2017 CTC performed field engineering surveys in New Mexico focusing on areas that, based on the New Mexico Broadband Map, are the underserved parts of the State.

The field surveys included underserved areas in downtown Santa Fe, the Old Santa Fe Trail area, Pojoaque, Espanola, Cundiyo, Ponderosa, Canon, Jemez Springs, Rio Rancho, and several reservation areas.

General Findings

Many areas in the major cities that appear to only have DSL in a single- or a several-block radius are covered by other services as well. In these cases, there is CATV plant or fiber along one or more boundaries of the block.

Albuquerque

The area along Broadway Boulevard, south of Route 500 has only DSL service available, as shown on the New Mexico Broadband Map. The DSL plant is mainly located either on the pole lines along the east side of the road with risers or buried cable under Broadway to the business locations along the west side.

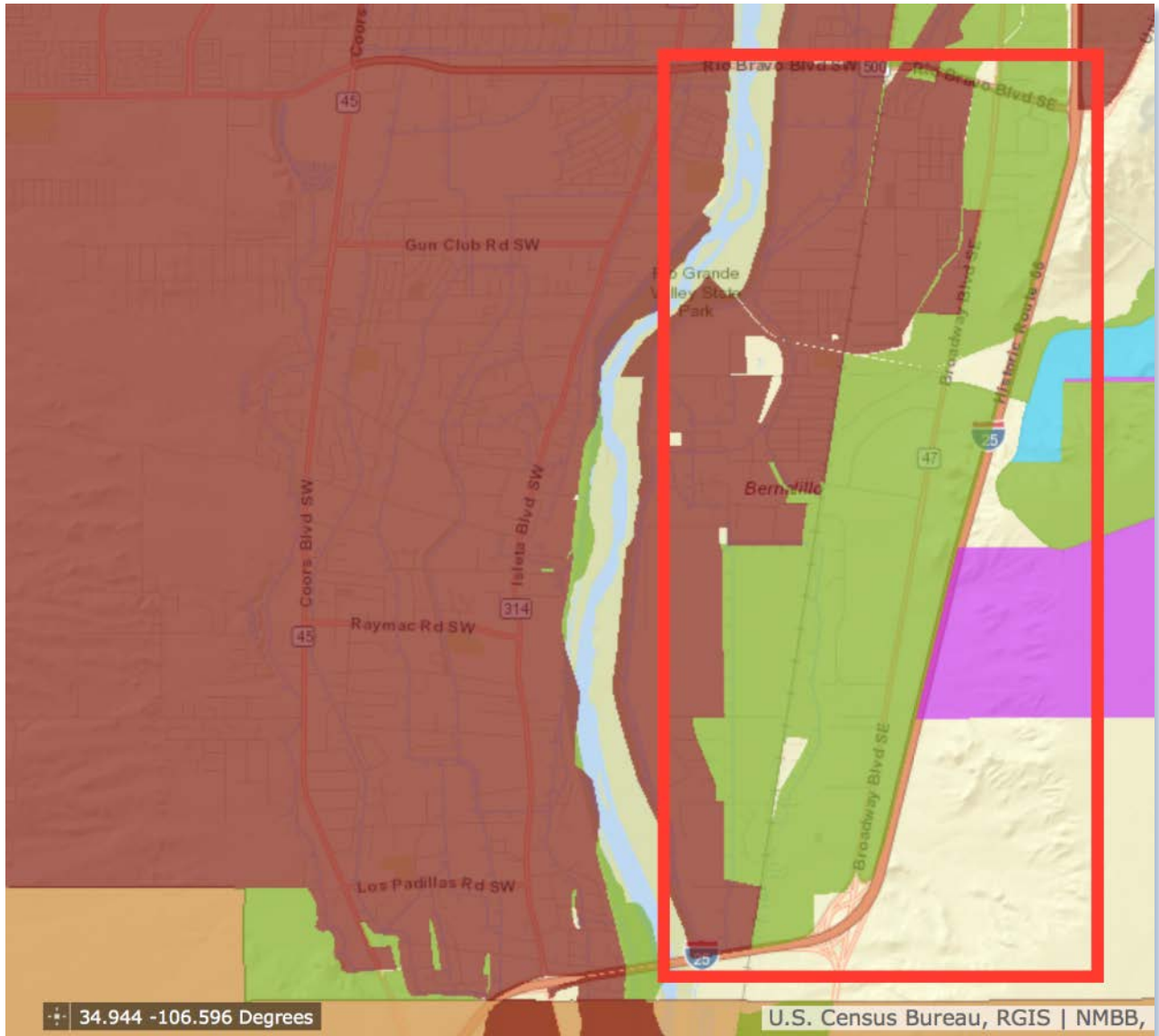

Figure 36: Broadway Boulevard, South of Route 500

The area west of Albuquerque, along the Route 66 and Route 40 junction, in the industrial park and surrounding areas, is fed by CATV.

The Casino at the Downs in Albuquerque is shown in the current New Mexico Broadband Map as only having DSL, but the casino has a CATV pedestal on the grounds and is surrounded by CATV plant on all sides. The race track is fed by copper with no clear evidence of other services on the property.

Though this area has CATV plant, expanding into areas that are currently unserved by CATV may be expensive because of the railroad crossings that will be required.



Figure 37: Telephone Lines on Broadway Boulevard



Figure 38: Broadway Boulevard

Bernalillo

Bernalillo is, for the most part, fed with CATV except for the reservation areas. The region around the Santa Ana Star Casino appears to be served only by DSL. The New Mexico Broadband Map shows that the casino is served by fiber, but CTC was not able to locate evidence of fiber plant. There are CATV pedestals throughout this area as well.

Downtown Santa Fe

In downtown Santa Fe, CTC found that many businesses were using wireless or satellite internet connections instead of wireline technologies (Figure 39).



Figure 39: Downtown Santa Fe – Assorted Cables to Rooftop

Existing wireline utilities tend to be very old and cable pathways tend to run underground and inside buildings. In some areas, the pathway goes from building to building in an ad hoc manner (Figure 40). These factors may make new construction complex and expensive with construction causing a relatively high impact to the surrounding area.



Figure 40: Downtown Santa Fe – Ad Hoc Telecommunications Cabling Hanging from Building to Building

In this case and in other similar areas, microtrenching may be a good approach to new construction as it is relatively low-impact and low-cost. Microtrenching involves cutting a relatively shallow and narrow pathway directly into existing concrete or asphalt, potentially into the curb, inserting microduct into the pathway, and filling the rest of the cut, as shown in Figure 41 and Figure 42 below. This method is significantly faster, less expensive, and less disruptive than traditional trenching.



Figure 41: Downtown Santa Fe – Curb Providing Opportunity for Microtrench Construction

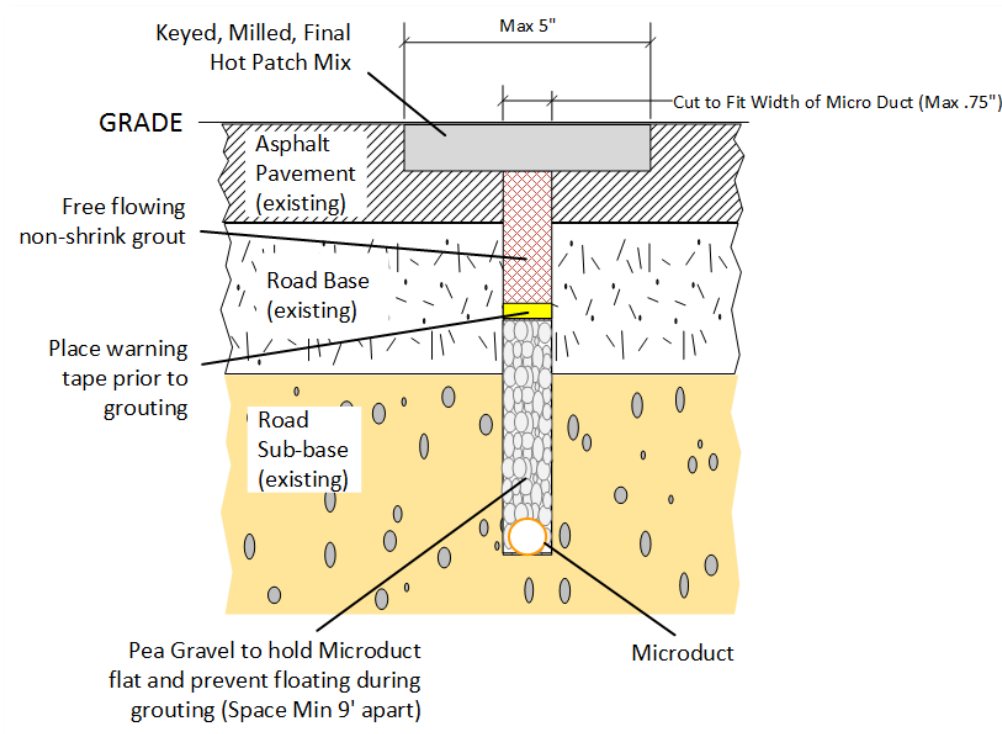

Figure 42: Microtrench Cross-Section View

Old Santa Fe Trail Area

In the Old Santa Fe Trail area northeast of Santa Fe, CTC found that DSL was the only available wireline service. This area is largely composed of high-end, single-family homes at a relatively high density (a higher density of homes tends to make the per-home cost of fiber construction cheaper) and, per the Infogroup data, includes home-based businesses. Existing utility poles appear to have space for additional attachment (Figure 43 and Figure 44), and the dirt roads in the area would also make underground construction relatively inexpensive so long as there are not environmental restrictions.



Figure 43: Old Santa Fe Trail – Poles with Ample Space for Broadband Attachment



Figure 44: Old Santa Fe Trail – Poles with Ample Space for Broadband Attachment

Pojoaque, Española, and Cundiyo

NMBB maps indicate the Pueblos of Pojoaque and Española have no coaxial cable service available except in a small area of Pojoaque along NM Route 502 near the western edge. However, both appear to have CATV and phone plant.

The CATV plant in Española appears to be old and may require fiber extension to the cable nodes as well as other upgrades before the existing CATV plant can be used for cable broadband service. Cundiyo does not

appear to have coaxial cable plant inside the City or along NM Route 503, but there is cable plant installed along NM Route 76 east of NM Route 503. The CATV plant in this area may require similar upgrades.

Rio Rancho

Within Rio Rancho, most areas shown as DSL-only actually have CATV plant throughout. In the limited areas where CATV service is not available, CATV plant could be extended to the area by a directional drill shot underneath roads. Most of the roads that need to be crossed are multi-lane roadways which may increase instruction cost.

The large area west of Rio Rancho is largely green space, with only copper phone lines, which may or may not be able to support DSL service. This entire area should be considered a DSL-only region.

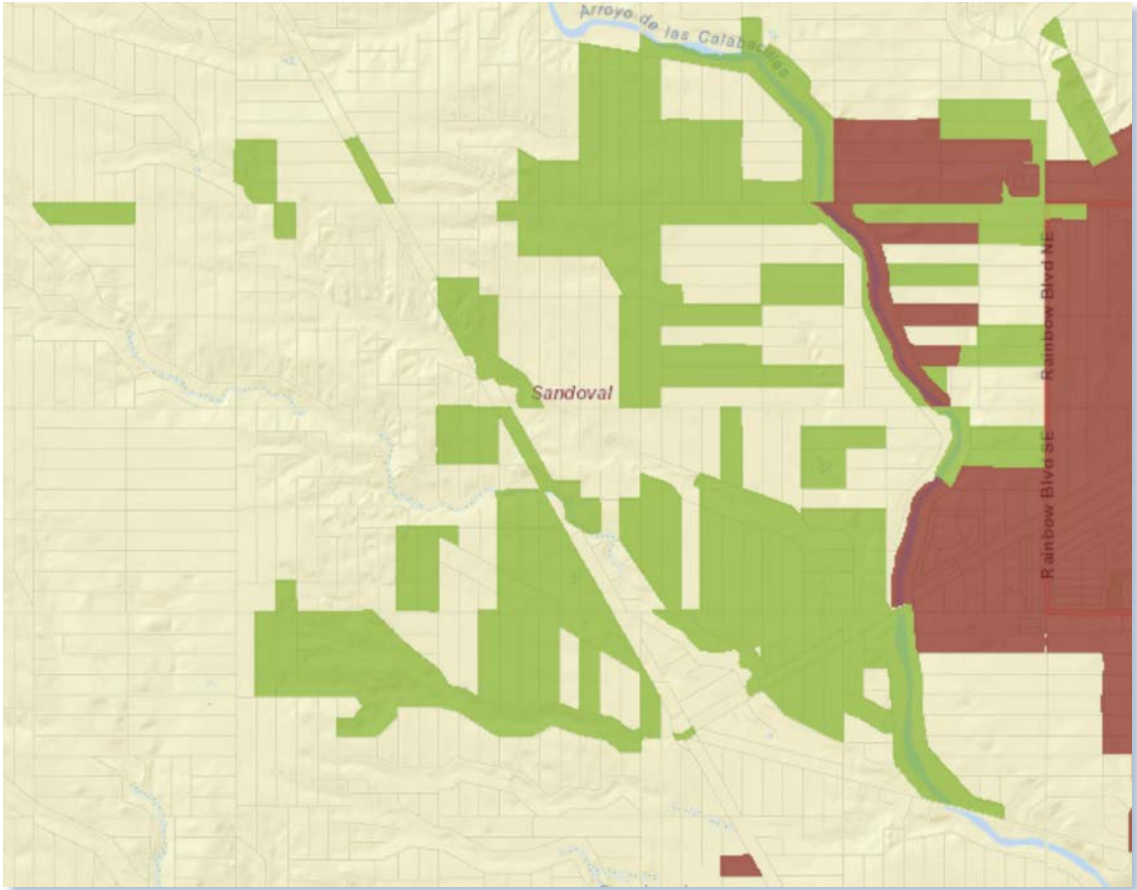

Figure 45: DSL-Only Region West of Rio Rancho



Figure 46: Rio Rancho Copper Telephone Lines



Figure 47: Rio Rancho Copper Telephone Lines



Figure 48: Rio Rancho Buried Telephone Infrastructure

Reservation Areas

Many reservations do not have anything other than copper phone lines within the reservation.

CTC's field survey found that many of the reservations, including Ponderosa, Cañon, and Jemez Springs, are a considerable distance from existing CATV plant. Serving these areas with FTTP or HFC would require a very high-mileage fiber deployment and may be cost prohibitive. In these areas, it may be more cost-effective to expand DSL service using existing telephone lines, which would be limited by the size of existing copper cables and the extent to which line doublers could be used to increase the number of services transmitted over those cables.

Many of the areas shown as DSL-only on the NMBB Maps are greenspace regions which do not contain homes or businesses. Greenspaces adjacent to existing CATV plant will be fed with the continuation of developments and growth in the region.



Figure 49: Reservation Area CATV Infrastructure



Figure 50: Reservation Area Copper Telephone Infrastructure

Google Earth Surveys

As a complement to its field surveys, CTC used Google Earth to survey the broadband infrastructure in additional areas of New Mexico.

CTC found that pole lines generally extend out along the main roadways about 15 miles from a city, at which point cabling is then buried until it reaches roughly 15-miles from the next city.

Some of the observations CTC had on various cities are as follows:

- Along Route 66, there is buried telephone plant (copper) that runs parallel to the pole lines.
- In **Socorro** and **Gallup**, many of the poles in the region have CATV infrastructure. The New Mexico Broadband Map indicates that Socorro has only DSL service.
- In **Loco Hills**, there is buried telephone plant with no visible CATV plant.
- In **Artesia**, CATV plant is present on most pole lines.
- In **Thoreau**, no aerial or buried CATV plant is visible but the telephone plant is buried.
- In **Eldorado at Santa Fe**, there is both power and telephone buried plant. Some areas do have buried CATV with visible pedestals.
- In **Church Rock**, there is CATV plant on the poles along Indian Service Route 7048. Other regions have CATV plant on the pole lines bordering underserved areas with laterals extending into them.
- In **Crownpoint**, telephone plant is both aerial and buried. There is no CATV plant visible, either aerial or buried.
- In **Truth or Consequences**, CATV plant is present throughout the town.
- In **Ruidoso**, CATV plant is present throughout town.
- In **Santa Rosa**, CATV plant is present throughout town.
- In **Portales**, CATV plant is present in most of the town. ENMU has buried plant throughout campus, including both telephone and CATV.
- In **Pojoaque**, the main roads show buried telephone plant.

Appendix F: Glossary of Terms

Access Fiber – The fiber in an FTTP network that goes from the FDCs to the optical taps that are located outside of homes and businesses in the PROW.

AE – Active Ethernet; a technology that provides a symmetrical (upload/download) Ethernet service and does not share optical wavelengths with other users. For subscribers that receive AE service—typically business customers that request a premium service or require greater bandwidth—a single dedicated fiber goes directly to the subscriber premises with no optical splitting.

CPE – Customer premises equipment; the electronic equipment installed at a subscriber’s home or business.

Dark Fiber – Fiber optic strands that are installed in underground conduit or attached to utility poles, but are not “lit” by network electronics.

Distribution Fiber – The fiber in an FTTP network that connects the hub sites to the fiber distribution cabinets.

Drop – The fiber connection from an optical tap in the PROW to the customer premises.

FDC – Fiber distribution cabinet; houses the fiber connections between the distribution fiber and the access fiber. FDCs, which can also house network electronics and optical splitters, can sit on a curb, be mounted on a pole, or reside in a building.

FTTP – Fiber-to-the-premises; a network architecture in which fiber optics are used to provide broadband services all the way to each subscriber’s premises.

GPON – Gigabit passive optical network; the most commonly provisioned FTTP service—used, for example, by Verizon (in its FiOS systems), Google Fiber, and Chattanooga Electric Power Board (EPB). GPON uses passive optical splitting, which is performed inside FDCs, to connect fiber from the Optical Line Terminals (OLTs) to multiple customer premises over a single GPON port.

IP – Internet Protocol; the method by which computers share data on the internet.

LEC – Local Exchange Carrier; a public telephone company that provides service to a local or regional area.

MDU – Multi-dwelling unit; a large building with multiple units, such as an apartment or office building.

OLT – Optical line terminal; the upstream connection point (to the provider core network) for subscribers. The choice of an optical interface installed in the OLT determines whether the network provisions shared access (one fiber split among multiple subscribers in a GPON architecture) or dedicated AE access (one port for one subscriber).

OSP – Outside plant; the physical portion of a network (also called “layer 1”) that is constructed on utility poles (aerial) or in conduit (underground).

OSS – Operational Support Systems (OSS); includes a provider’s provisioning platforms, fault and performance management systems, remote access, and other OSS for FTTP operations. The network’s core locations house the OSS.

OTT – Over-the-top; content, such as voice or video service, that is delivered over a data connection.

Passing – A potential customer address (e.g., an individual home or business).

POTS – “Plain old telephone service;” delivered over the PSTN.

PROW – Public right-of-way; land reserved for the public good such as utility construction. PROW typically abuts public roadways.

PSTN – Public switched telephone network; the copper-wire telephone networks that connect landline phones.

QoS – Quality of service; a network’s performance as measured on a number of attributes.

VoIP – Voice over Internet Protocol; telephone service that is delivered over a data connection.

Appendix G: Abbreviations and Acronyms

Acronym	Definition
ADSL	Asymmetric Digital Subscriber Line
AE	Active Ethernet
BB4B	Broadband for Businesses
CAF	Connect America Fund
CATV	Cable Television
CO	Central Office
CPE	Customer Premises Equipment
CTC	Columbia Telecommunications Corporation
DIA	Dedicated Internet Access
DOCSIS	Data Over Cable Service Interface Specification
DSL	Digital Subscriber Line
DSLAM	Digital Subscriber Line Access Multiplexer
EDAC/UNM	Earth Data Analysis Center at the University of New Mexico (UNM)
FTTN	Fiber to the Node
FTTP	Fiber to the Premises
GPON	Gigabit Passive Optical Network
HFC	Hybrid Fiber-Coaxial
ISP	Internet Service Provider
MPLS	Multiprotocol Label Switching
NMBBP	New Mexico Broadband Project
NMECG	New Mexico Exchange Carrier Group
NOC	Network Operations Center
OBI	Office of Broadband and Geospatial Initiatives
POP	Point of Presence
RFP	Request for Proposals
VDSL	Very High-Rate Digital Subscriber Line

End Notes

¹ CTC is a 34-year-old communications technology consultancy with experience across a full range of technologies. CTC has planned, designed, or evaluated hundreds of fiber optic and wireless networks since 1983. In recent years, CTC has provided evaluative, strategic, planning, and engineering services for the statewide fiber network in Maryland (which serves schools, libraries, public safety, public health, and government institutions) and for the three-state regional fiber network in the National Capital Region; has provided strategic and business planning services for the statewide fiber network in Pennsylvania (which serves education and health care users); and developed the reference architecture for the national fiber-to-the-home network currently being built in New Zealand. CTC has consulted to the cities of San Francisco, Seattle, Los Angeles, and Washington, D.C. regarding broadband needs, as well as to the states of Delaware, Kansas, Maryland, Massachusetts, New Mexico, and New York.

² The preliminary report was released publicly and is available on the DoIT OBGi website:

http://www.doit.state.nm.us/broadband/reports/BB4B_CTC_Report_Policy_Considerations-final20170117.pdf

³ CTC has incorporated the planning and documentation products from the State Broadband Initiative grant (now the New Mexico Broadband Program) as well as information from other State broadband implementation projects such as the Governor's Broadband for Education (BB4E) Initiative and the New Mexico Public Safety Broadband Network (NMPSBN).

⁴ Connect America Fund; <https://www.fcc.gov/general/connect-america-fund-caf>

⁵ New Mexico Broadband Map, <https://nmbbmapping.org/mapping/>

⁶ New Mexico Broadband Map, <https://nmbbmapping.org/mapping/>

⁷ Data from Infogroup. The business locations have been added to the NMBB map during the course of the analysis.

⁸ Service providers use a technique known as "oversubscription" in which they can successfully deliver a high peak speed over a shared infrastructure. Given that individual users have widely fluctuating usage, and that few users sustain more than tens of Mbps at any given time, service providers including Google Fiber and Chattanooga EPB routinely provide 1 Gbps service over this type of infrastructure, and GPON is the platform that most providers use to deliver "gigabit" service.

⁹ Almost all cable systems in the U.S. currently have less than 50 MHz of bandwidth in the upstream direction.

¹⁰ "An evolutionary approach to Gigabit-class DOCSIS," *CED Magazine*, July 5, 2012,

<http://www.cedmagazine.com/articles/2012/07/an-evolutionary-approach-to-gigabit-class-docsis>

¹¹ Mikael Ricknas, "Gigabit speeds over telephone wires get closer thanks to new G.fast standard," *PCWorld*,

<http://www.pcworld.com/article/2856532/gigabit-speeds-over-telephone-wires-get-closer-thanks-to-new-gfast-standard.html>

¹² LTE is a 4G cellular wireless technology offering data speeds of typically around 30 Mbps.

¹³ "Development of IMT-Advanced: The SMaRT approach," Stephen M. Blust, International Telecommunication Union,

<http://www.itu.int/itu-news/manager/display.asp?lang=en&year=2008&issue=10&ipage=39&ext=html>

¹⁴ Such as LTE Advanced under development.

¹⁵ "ITU softens on the definition of 4G mobile," *NetworkWorld*, December 17, 2010,

<http://www.networkworld.com/article/2197135/wireless/itu-softens-on-the-definition-of-4g-mobile.html>

¹⁶ Based on Infogroup database

¹⁷ Although telecommunications also includes voice-only telephone lines, these increasingly are also migrating to broadband voice-over-IP.

¹⁸ Based on data in Infogroup database.

¹⁹ "Internet Connectivity and Utilization in Tennessee 2016, prepared for the TN Department of Community and Economic Development," report prepared by NEO Connect and Strategic Networks Group: The Broadband Economists. <http://www.tn.gov/assets/entities/ecd/attachments/broadband-study.pdf>, accessed 8 May 2017.

²⁰ Imme Philbeck, "Working Together to Connect the World by 2020: Reinforcing Connectivity Initiatives for Universal and Affordable Access," Discussion paper for a special session of the Broadband Commission for Sustainable Development, Geneva, 2016. <http://www.broadbandcommission.org/Documents/publications/davos-discussion-paper-jan2016.pdf>.

²¹ Data on the cost saving measures that the use of internet tools and online platforms provide is widespread. See the

graph provided on slide 47 of Eric Frederick, “How Does Broadband Contributes to Economic Development.” Included in “Broadband and Economic Development” webinar presentation in Washington, DC November 16, 2016 for the BroadbandUSA program under the National Telecommunications and Information Administration. A good graphic comparative representation of the difference between traditional and digital advertising appears in a marketing blog post at: <https://seriouslysimplemarketing.com/traditional-vs-online-marketing/>.

²² Data reflecting associations between broadband speed and business revenue provided on slide 46 of Eric Frederick, “How Does Broadband Contributes to Economic Development.” Included in “Broadband and Economic Development” webinar presentation in Washington, DC November 16, 2016 for the BroadbandUSA program under the National Telecommunications and Information Administration.

²³ Numerous online discussions of the impact of website loading times on business concur that slow times dissuade potential customers and lower the number of successful transactions resulting from a visit. Slower speeds also impact Google rankings that hurts website rankings. See, for example, the blog post at: <https://blog.kissmetrics.com/speed-is-a-killer/>.

²⁴ <https://www.nmlegis.gov/Sessions/17%20Regular/final/HB0060.pdf>

²⁵ The speed test is available publicly at <http://nmbbmapping.org/speedtest/>

²⁶ New Mexico Broadband Map, <https://nmbbmapping.org/mapping/>

²⁷ These case studies are based on CTC’s first-hand knowledge. As the broadband consultant to both cities, CTC provided strategic, business planning, and technical guidance to shape their initiatives.

²⁸ File 15-399, “Action Item,” City Council Meeting Agenda, City of Culver City, November 9, 2015, <https://culver-city.legistar.com/LegislationDetail.aspx?ID=2511600&GUID=46DF47E9-A9AF-4499-9ED2-24146E53D467&Options=&Search=>

²⁹ “Groundbreaking for Municipal Fiber Network, Culver Connect,” Culver City website, August 30, 2016, <http://www.culvercity.org/Home/Components/News/News/246/722?backlist=%2F>

³⁰ RFP, City of Vallejo, <http://www.ci.vallejo.ca.us/common/pages/DisplayFile.aspx?itemId=5206059>

³¹ “The Project,” Inter-County Broadband Network, <http://goo.gl/GjBC26>

³² See “Westminster Technology Park: A Carroll County Economic Development Initiative,” brochure http://www.carrollbiz.org/realestate/propertypdfs/WestminsterTechParkBro_low.pdf

³³ “A Brief Overview of Broadband Deficiencies in Connecticut,” CTC Technology & Energy, January 2016, http://www.ct.gov/occ/lib/occ/2016-0124_ctc_report_on_connecticut_broadband_deficiencies.pdf

³⁴ Interview with Mr. Darrell Hill, Chief Operating Officer, and Ms. Sabina Sitaru, Chief Innovation Officer, City of Hartford, October 27, 2015

³⁵ Interview with Ms. Lisa Pellegrini, First Selectwoman, Town of Summers, October 27 2015

³⁶ New Mexico Broadband Map; <https://nmbbmapping.org/>

³⁷ EDAC/UNM: “New Mexico Broadband Mapping Program,” <http://edac.unm.edu/2011/07/nmbb/>

³⁸ Connect America Fund; <https://www.fcc.gov/general/connect-america-fund-caf>

³⁹ Price Cap Resources; <https://www.fcc.gov/general/price-cap-resources>

⁴⁰ Alternative Connect America Cost Model; <https://www.fcc.gov/general/rate-return-resources#model>

⁴¹ Connect America Phase II Auction; <https://www.fcc.gov/connect-america-fund-phase-ii-auction>