

# ELECTRIC GRID STABILITY IN A MULTI-SOURCE ENERGY MARKET : THE ROLE OF MICROGRIDS

Dr. Olga Lavrova

Klisch School of Electrical and Computer  
Engineering

Electric Utility Management Program



**BE BOLD.** Shape the Future.

# Basic structure of electric system

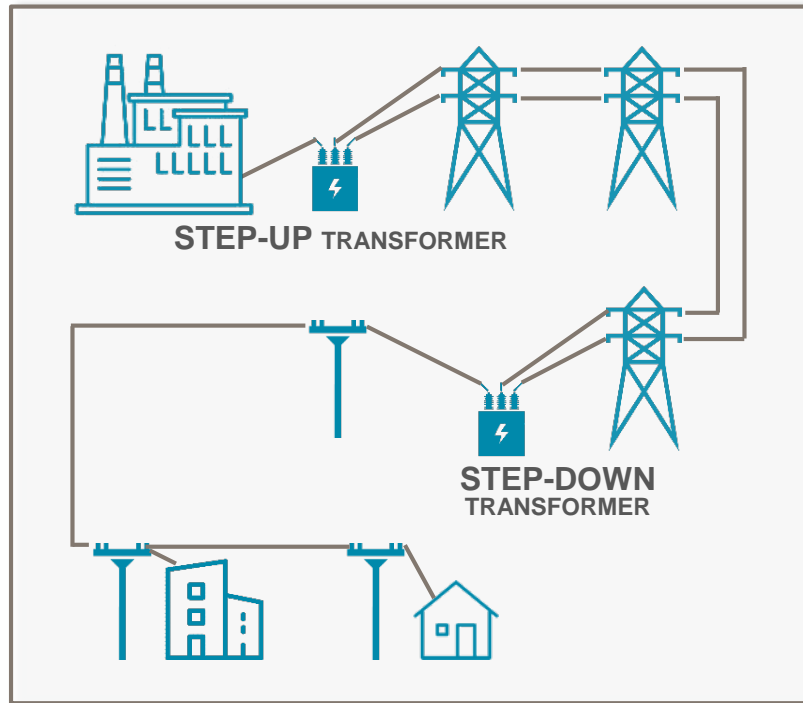
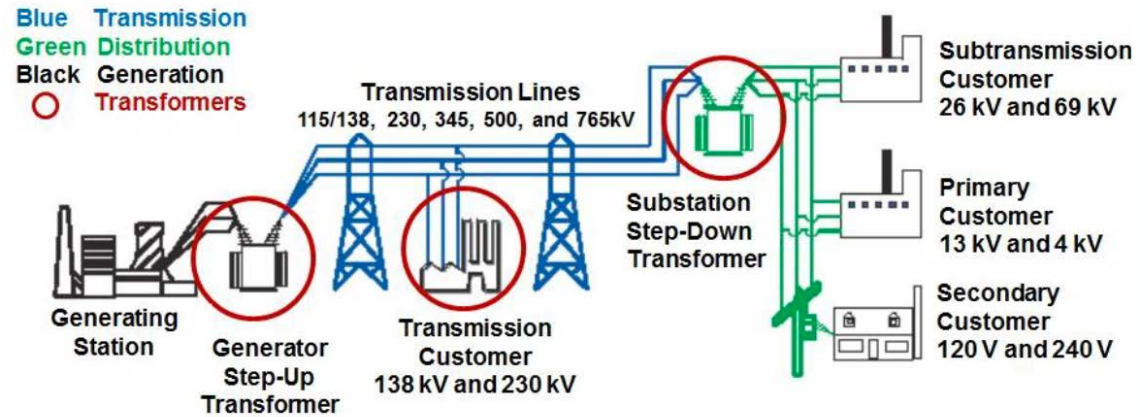

Figure 1. Electric Power Grid Representation



Source: DOE, 2006; see Footnote 14. Modified based on industry review.

Table 1. Transmission Voltage Classes

Class	Voltage Ratings (kV)
Medium Voltage	34.5, 46, 69, 115/138
High Voltage	115/138, 161, 230
Extra High Voltage	345, 500, 765

Source: DOE, 2006; see Footnote 14. Modified based on industry review.

# Yesterday's Power System ... One Way Power Flow

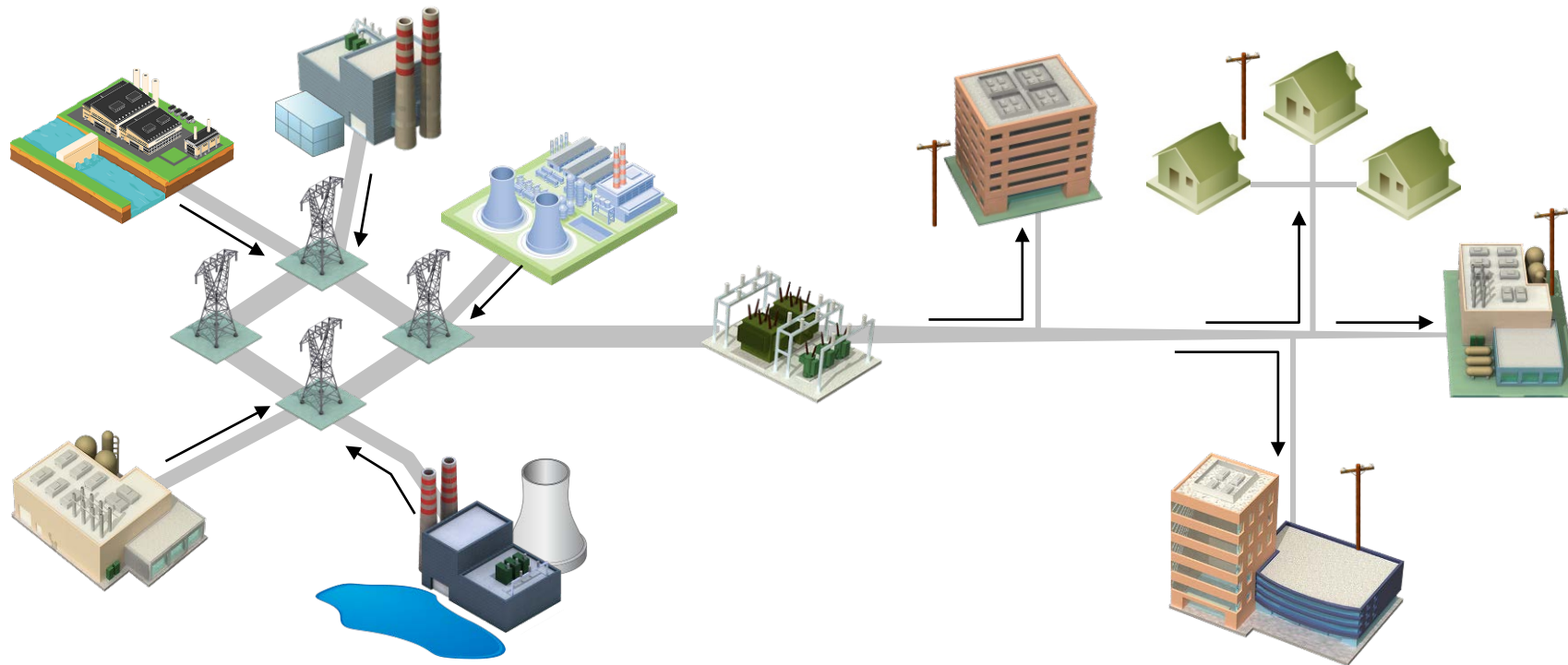

**Generation-Transmission**

**Substation**

**Distribution System**

# Today's Power System ... Two Way Power and Information Flow

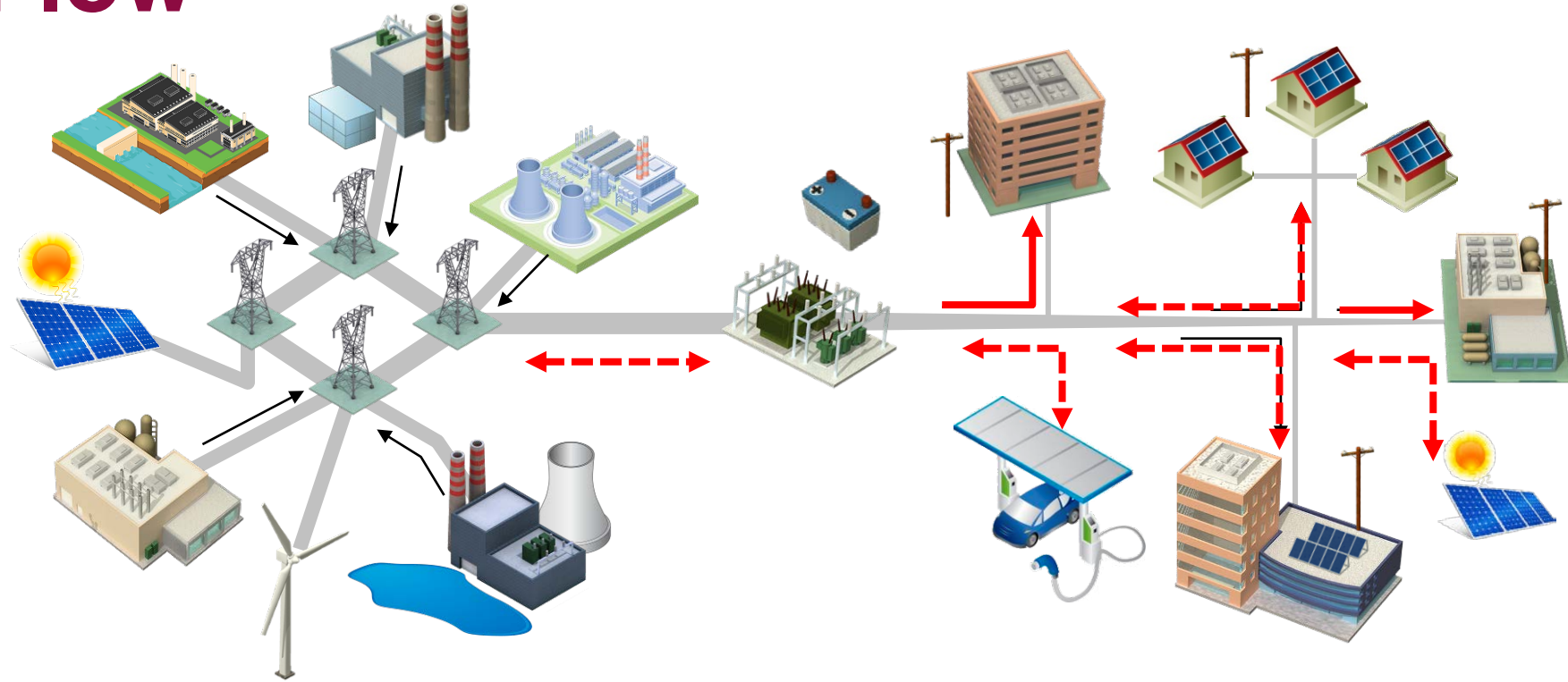

# Microgrid Definition

- There are many definitions for microgrid
- Definition according to DOE and EPRI:

*“ A group of interconnected loads and distributed energy resources (DERs) with clearly defined electrical boundaries that acts as a single controllable entity with respect to the grid, and can connect and disconnect from the grid to enable it to operate in both grid-connected or island mode”*

***“ To develop **optimal strategies** for integrating DER in the planning and operation of the grids of the future, these need to be viewed as an integral part of the bulk transmission system”***

Ref: “The integrated grid. Realizing the full value of central and distributed resources”  
Technical Report, EPRI 2014

Microgrids are localized grids that can disconnect from the traditional grid to operate autonomously. Because they are able to operate while the main grid is down, microgrids can strengthen grid resilience and help mitigate grid disturbances as well as function as a grid resource for faster system response and recovery.

Microgrids support a flexible and efficient electric grid by enabling the integration of growing deployments of distributed energy resources such as renewables like solar. In addition, the use of local sources of energy to serve local loads helps reduce energy losses in transmission and distribution, further increasing efficiency

of the electric delivery system.

Ref: <https://www.energy.gov/oe/activities/technology-development/grid-modernization-and-smart-grid/role-microgrids-helping>



# Benefits of microgrids ?

- Operation in grid-tied AND islanded modes
- Reliability and longer lifetime of equipment
- Resiliency to natural and man-made threats
- Higher efficiency of energy utilization
- Higher efficiency of Renewables utilization
- Customer flexibility and customer choice
- Energy savings, therefore energy bill savings
- Better quality of life for consumers

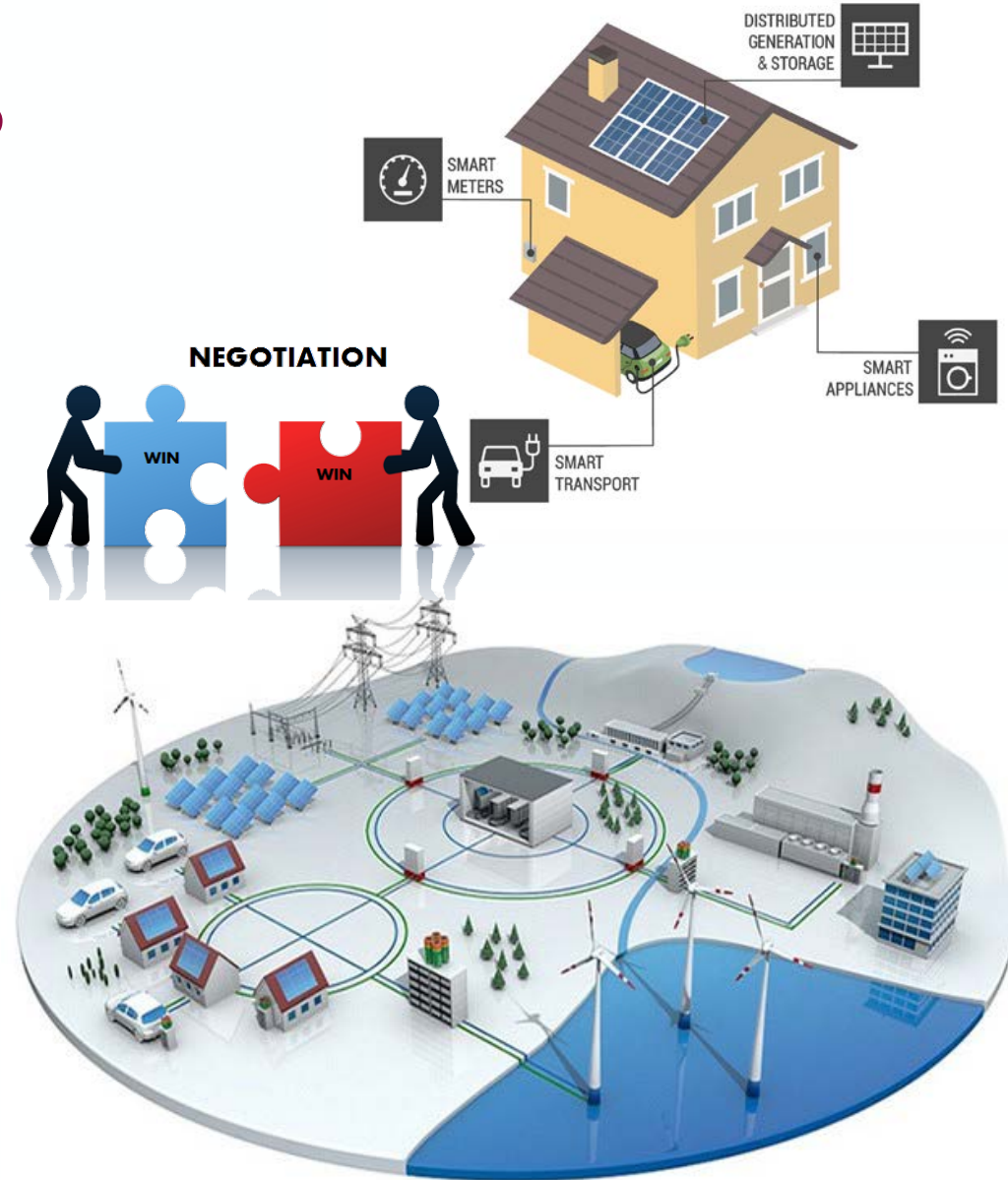

# Microgrids: What are the Opportunities?

- Jobs ! Jobs ! Jobs !
- Meeting ETA requirements
- Better quality of life for consumers

## What areas are needed?

- Electrical Engineering
- Communications and Networking
- Cybersecurity
- Markets, Economics
- Customer Service, Field Service



Secretary Jennifer Granholm  
@SecGranholm

New Mexico has enormous [#cleanenergy](#) potential and transmission is key to getting it where it needs to be. It was great to meet with those focused on transforming how NM is powered!

Thank you [@IBEW](#) Local 611, [@MartinHeinrich](#), [@RepStansbury](#), and Sec Cotrell Propst of [@EmnrdNM](#).



# Microgrid Components to Success:

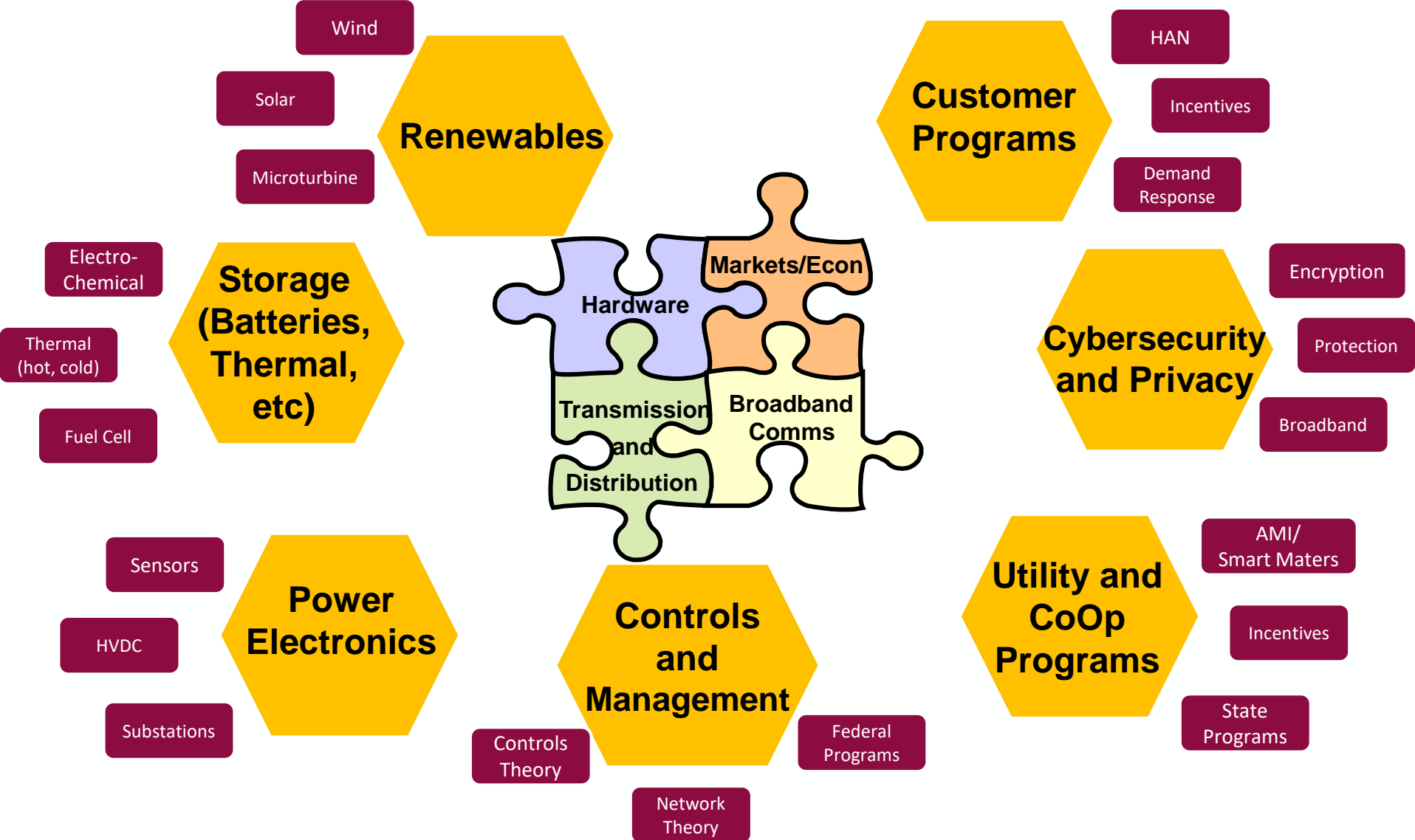



# Is cybersecurity important for electrified transportation?

## We've got a degree for that...



### B.S. in Cybersecurity Degree



BE BOLD. Shape the Future. | New Mexico State University | [www.cs.nmsu.edu](http://www.cs.nmsu.edu)

Program Starts Fall 2020



#### Why do a Bachelor's Degree in Cybersecurity?

- By 2021, it is estimated that there will be 6 million cybersecurity positions worldwide
- 28% cyber-security job growth through 2026, compared to national job growth rate will be 7%
- Cybersecurity is a multi-faceted and complex discipline, requiring formal education programs.
- 200,000 cybersecurity positions available nationally; increasing number of openings.
- Jobs include Cybersecurity Analyst; Security Architect; Cyber defense Expert; Cyber Vulnerability Analyst.



#### Degree Program Goal and Courses

##### Goal:

Produce competent graduates to secure regional, national and global cyberspace. Build a professionally trained cybersecurity workforce for industry, national laboratories, government, and academia.



##### Illustrative Courses:

Management of Information Security; Computer Science Principles; Introduction to Data Structures; Introduction to Cryptography; Operating Systems I; Computer Security; Computer Networks I; Introduction to Security Technology and Loss Prevention; Hardware Security and Trust; Introduction to Digital Forensics and Incident Response; Cloud and Edge Computing.

##### Contact:

Professor Jay Misra  
Director,  
BS Cybersecurity Program  
Email: [misra@nmsu.edu](mailto:misra@nmsu.edu)

CS Office  
Jaki Davis  
[jakidrew@nmsu.edu](mailto:jakidrew@nmsu.edu)



BE BOLD. Shape the Future.

# Microgrid Stability Control Systems:

- Core functions of microgrid controls:
  - Maintaining voltages, currents and frequency
  - Keeping the power supply and demand balanced
  - Economic dispatch and demand side management
  - Transitioning between modes of operation

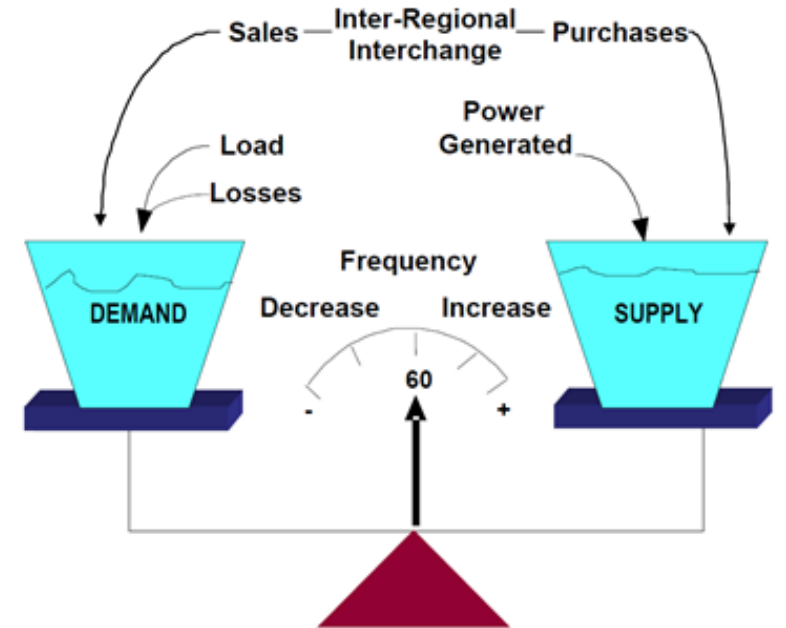

# Microgrid Primary control

- In grid-connected mode:
  - Voltage and frequency are mainly regulated by governing grid
  - Stability is mainly about individual or a set of DERs and loads
- In islanded mode:
  - Voltage and frequency are maintained by DERs
  - Various stability issues depend on the grid forming unit (inverter)

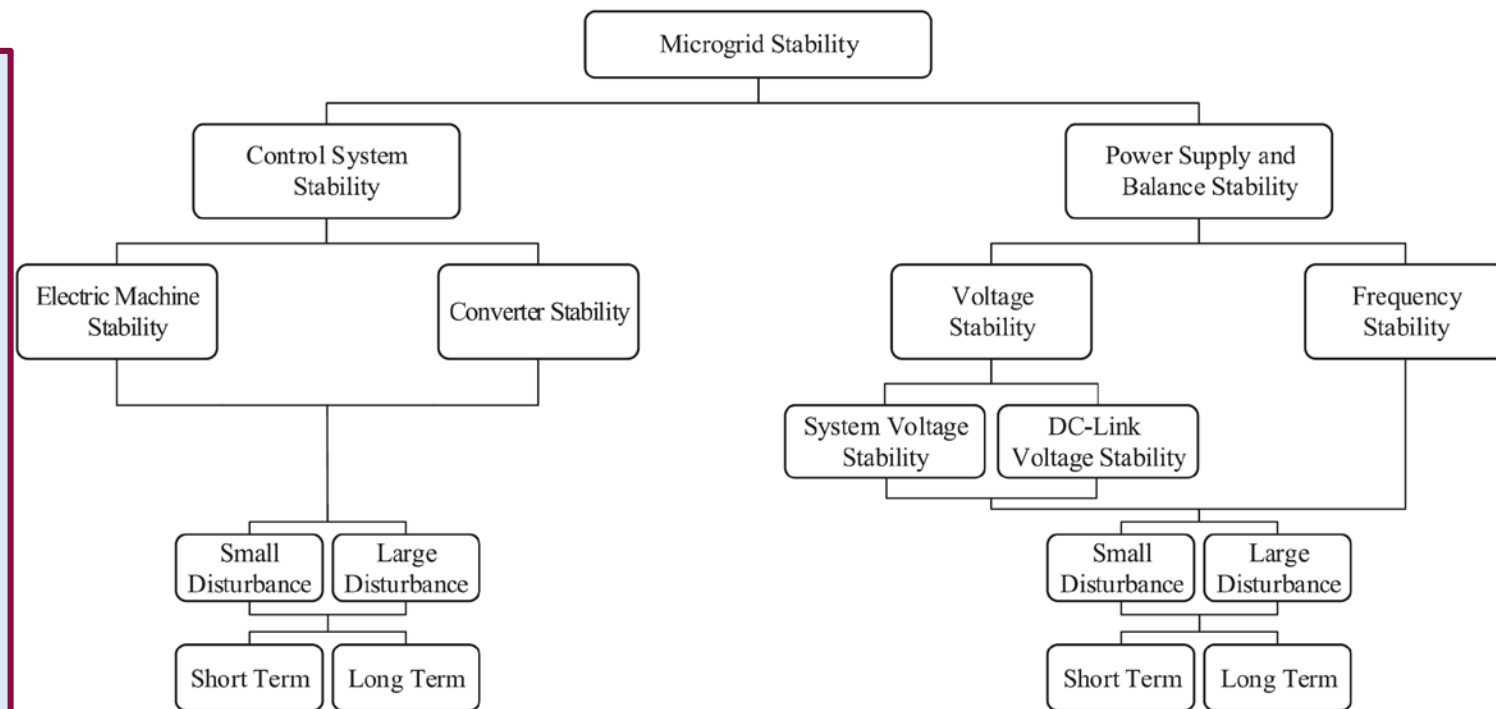

New types of stability are observed in microgrids. while some classical stability issues are not relevant

# Factors which may affect microgrid stability:

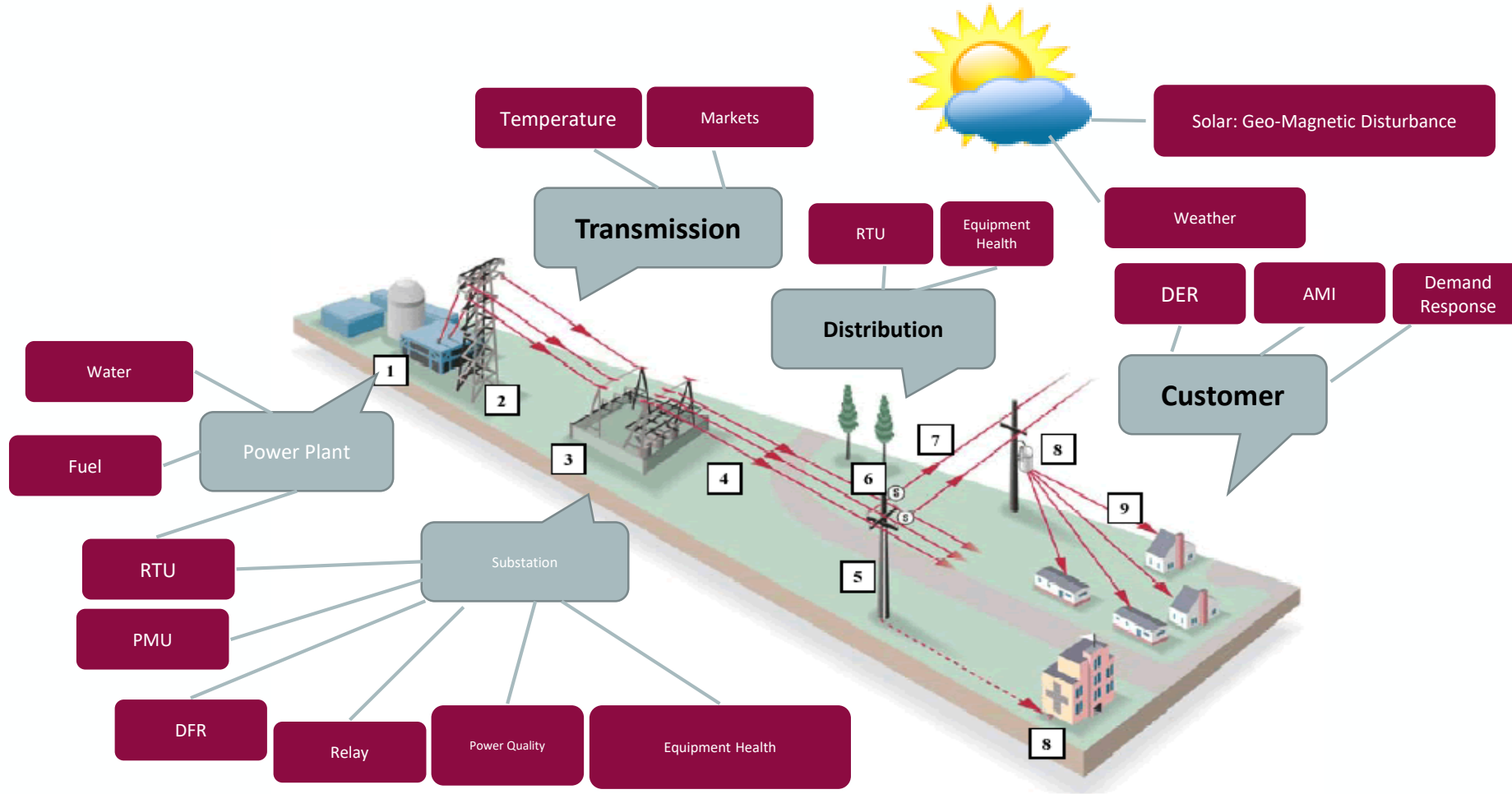

Modified from Duke Energy

<https://www.progress-energy.com/florida/home/safety-information/storm-safety-tips/restoration.page?>



# Examples of microgrids in New Mexico

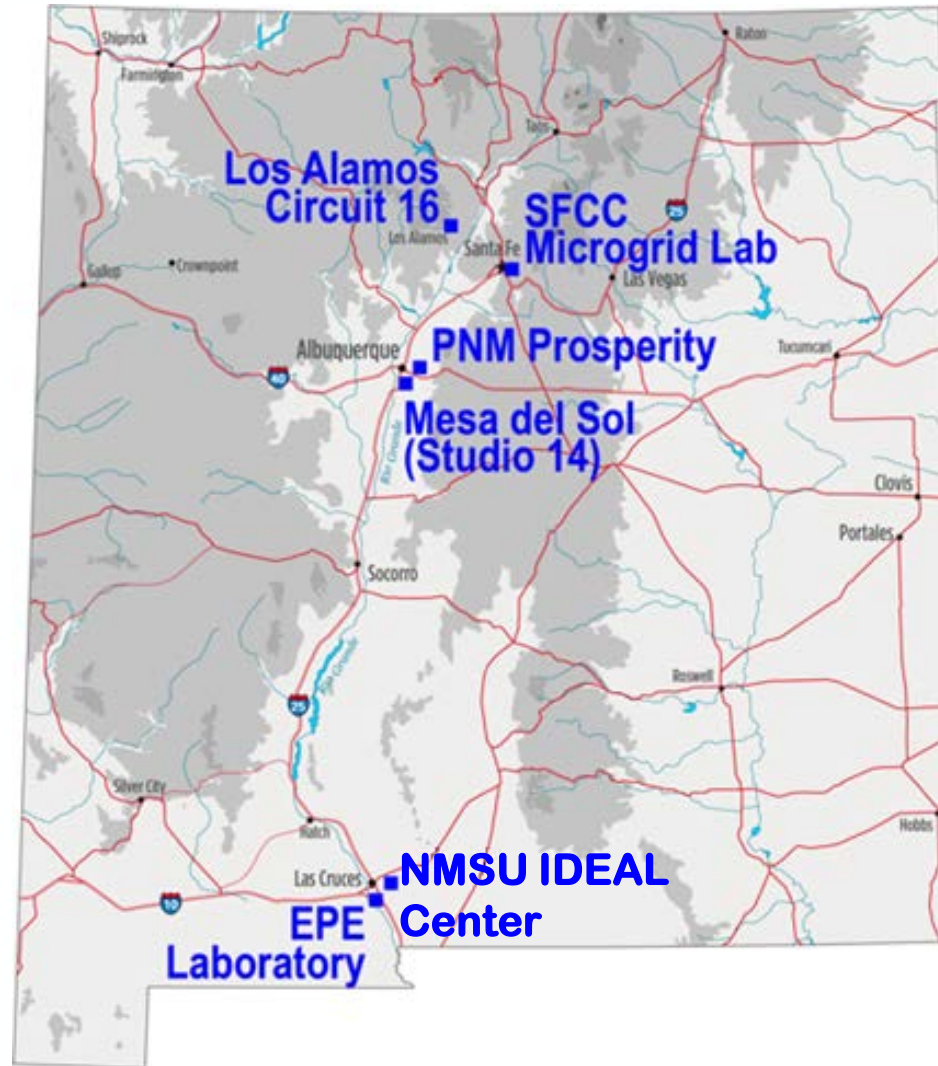



# NMSU Campus microgrid

NMSU AG Extension

Tri-generation Plant  
(Electricity, Steam,  
Chilled Water)

Existing: Passive sensible heat (rock)  
Planned: PCM (Engineering 1 bldg.)

Campus Health  
Center and Pharmacy

NMSU Main Campus

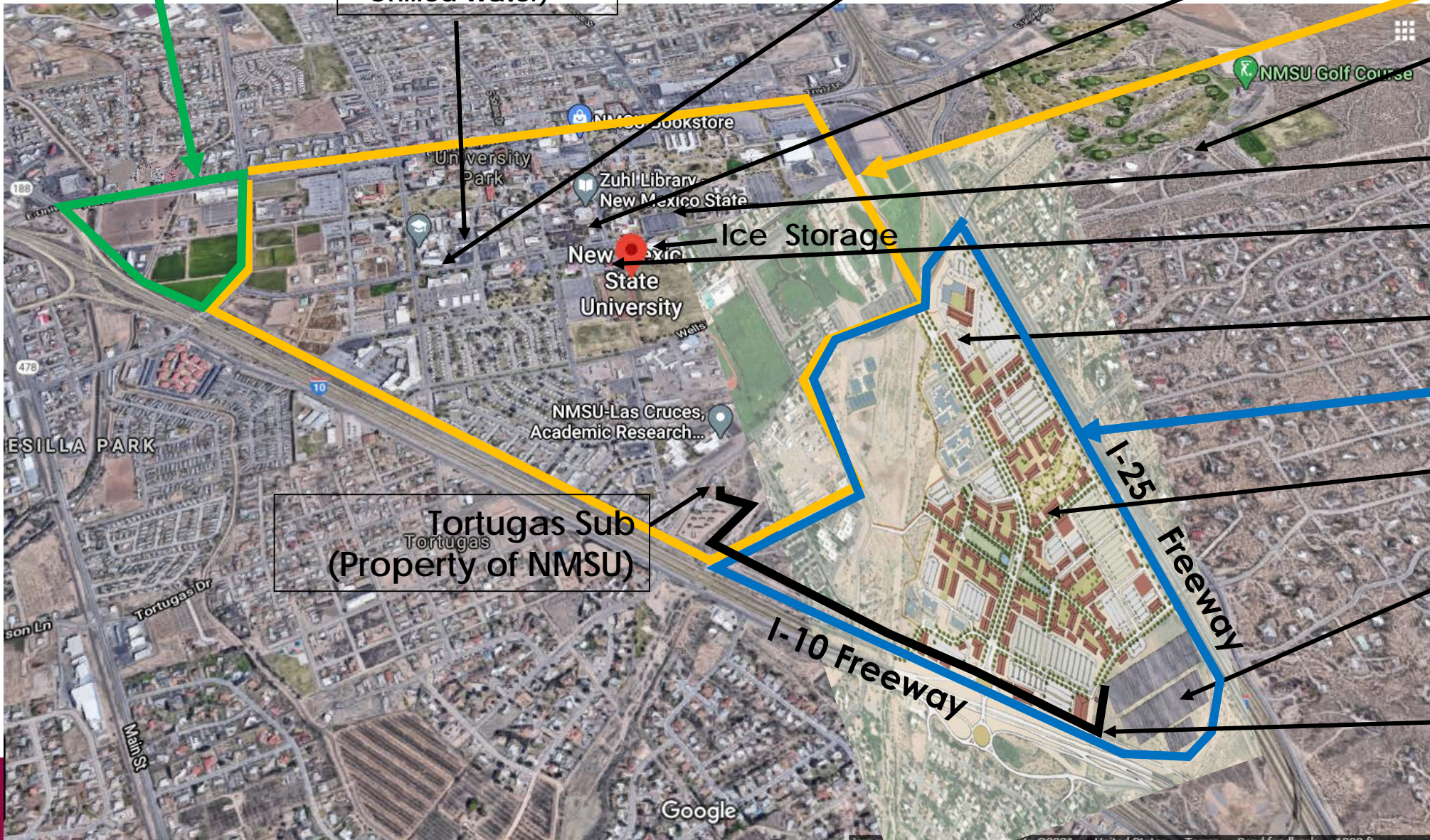

Geothermal Sub  
(Property of NMSU)

Existing: 200kW PV (parking)

Planned: Motor Pool EV  
charging

Planned: LDES thermal  
storage + microturbine

Arrowhead business park

Planned: critical power  
tenant with building-level  
storage

Existing Aggie Power:  
3MW PV +  
1MW/4MWh Li-Ion storage

PV+Storage interconnection  
to Tortugas Sub (23.9kV)



# NMSU Campus microgrid

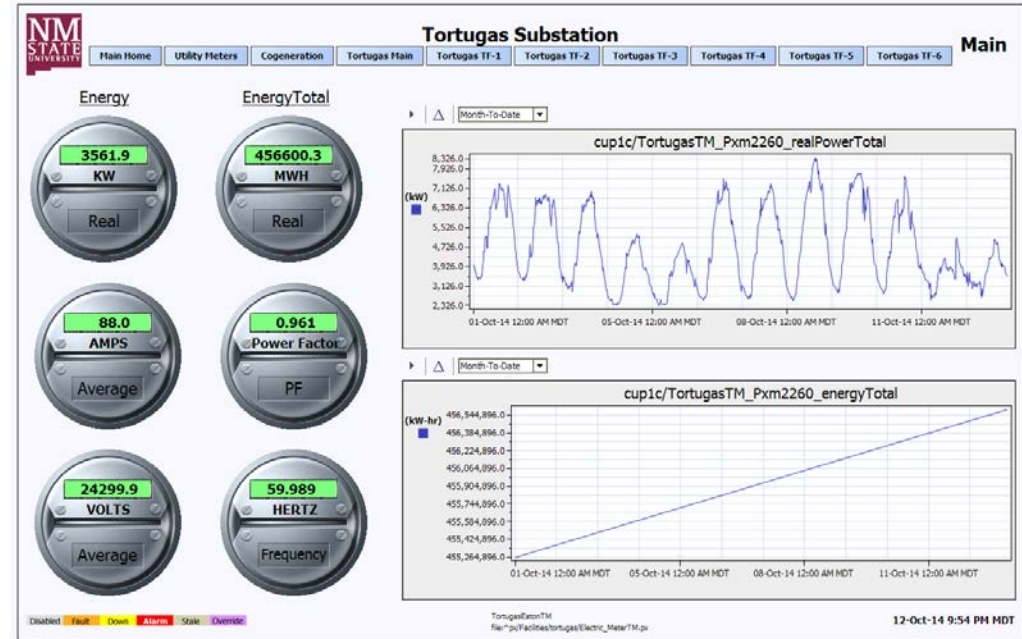
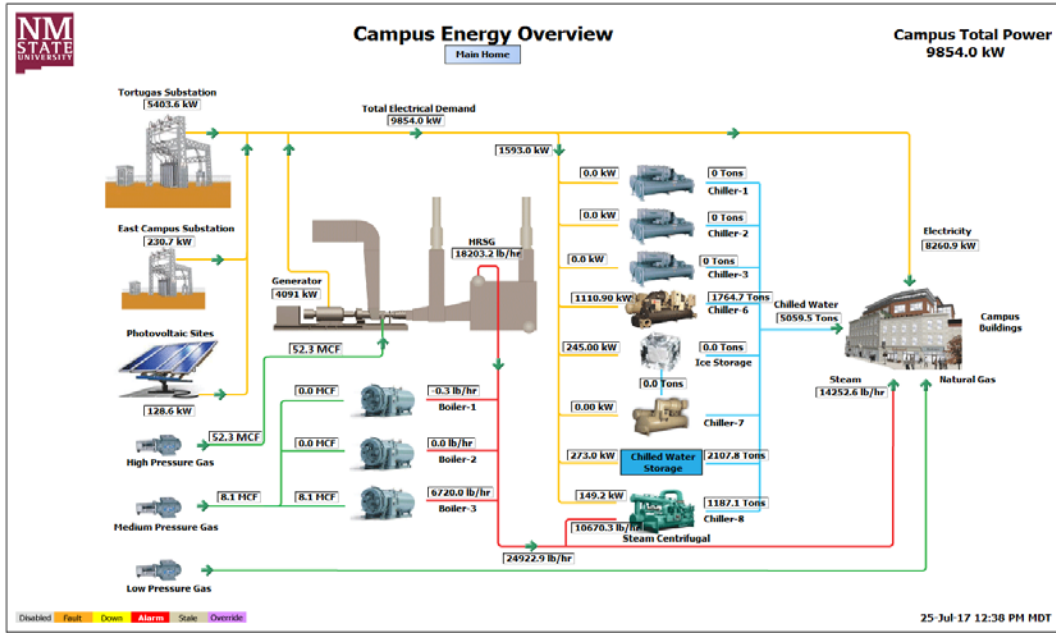

# Aggie Power Solar Project

- 3 MW Solar Array
- 1 MW / 4 MW hours battery storage system
- Owned & Operated by El Paso Electric
- Connected to NMSU distribution that will provide:
  - ⚡ Clean renewable energy
  - ⚡ Research and educational opportunities
- NMSU researchers to conduct microgrid research in collaboration with EPE





# NMSU IDEAL center: Living Testbed Microgrid

The micro-grid at IDEAL center is a three phase, 4kV feeder microgrid, interconnecting buildings containing PV interfaced with smart inverters, Controllable Loads, Electric Storage and cybersecurity equipment. SWTDI provides the platform to evaluate centralized or distributed algorithms for energy delivery.

Resources and plug loads can be controlled using Smart Outlets. The outlets are capable of providing sensing and measurement information (Voltage, Current, Phase, etc.) and control connected resources.

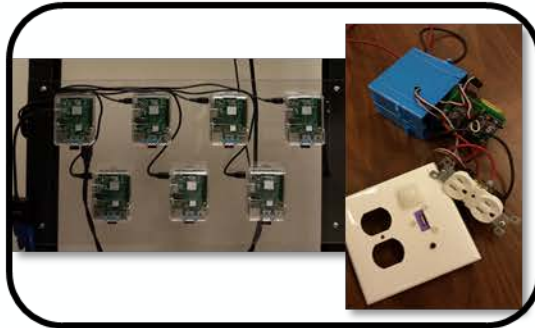

Raspberry Pis are being programed as agents to execute the centralized or distributed algorithms for Energy Delivery. Programmable loads and load banks can be controlled to emulate various operating conditions and loading scenarios.

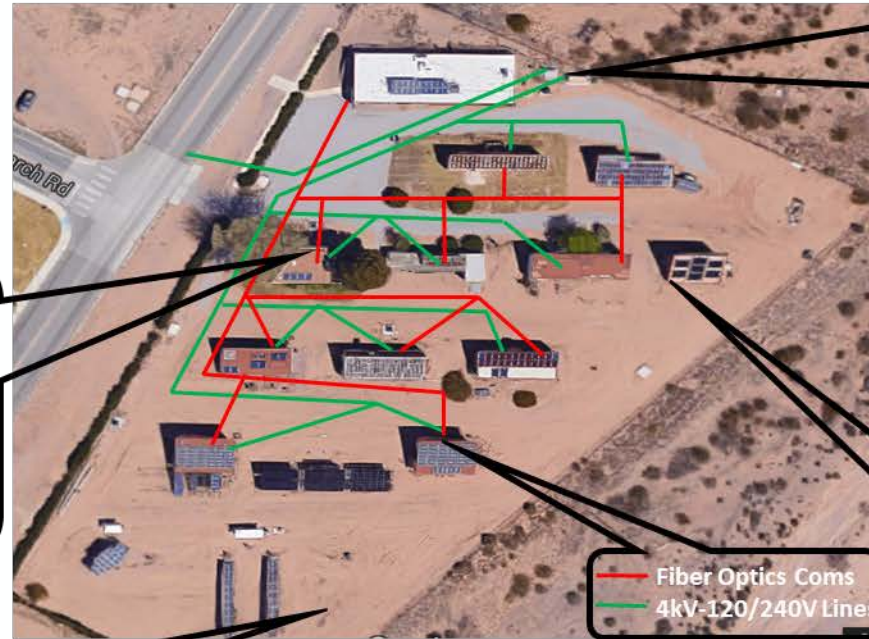

SWTDI can be islanded from the utility by operating a set of three-phase reclosers (controlled by NMSU). System can operate as a microgrid. PMUs are co-located and monitored for emulitics and Machine Learning analysis



Both grid-forming and grid-following inverters manage power and energy balance.



Aggie Power Solar+Storage installation is a 3MW PV (single axis tracking) and 1MW/ 4MWh storage is joint EPE / NMSU Research & Education Collaboration Agreement. Storage system will be controlled and dispatched for grid-support services.

# NMSU Engineering problem-solving for microgrids:

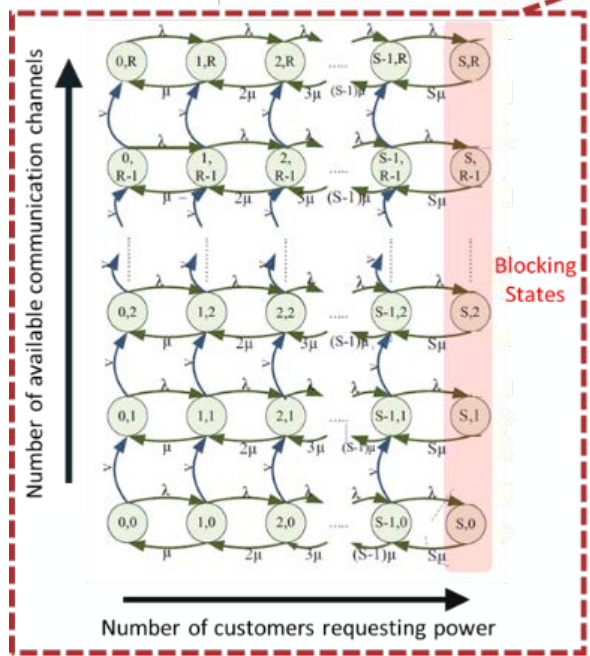
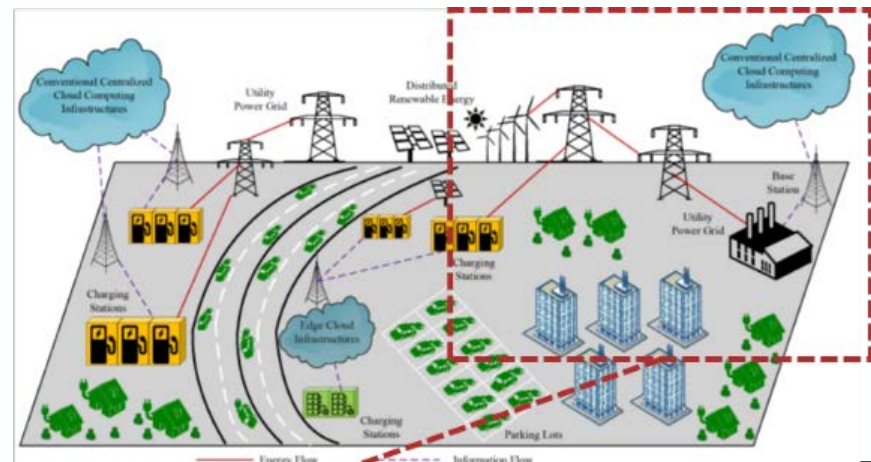
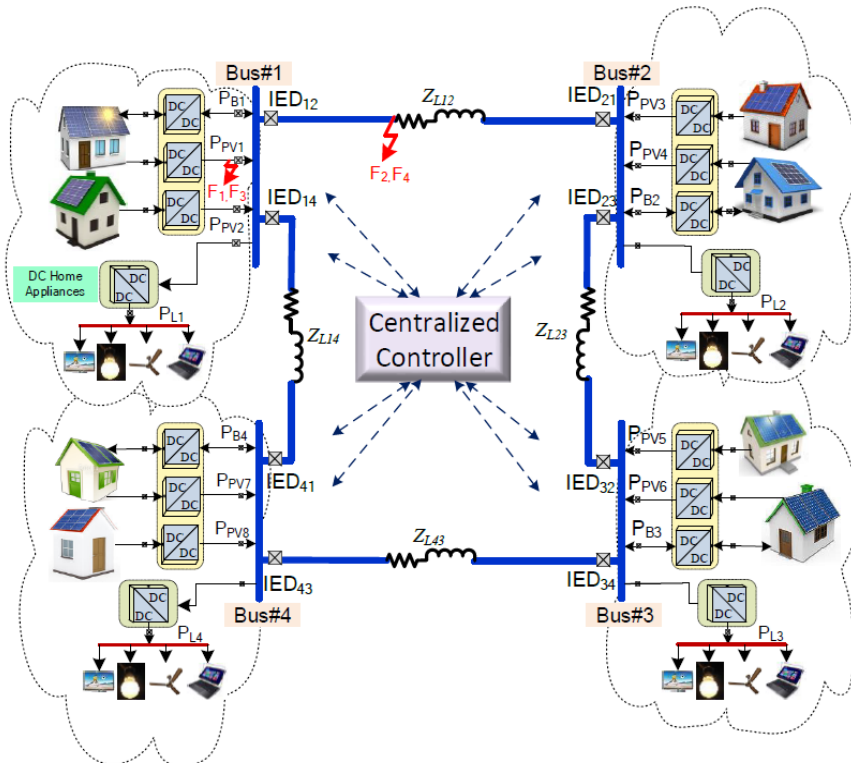

*Potential for operator overload as local devices grow*



## Novel Authentication Schemes

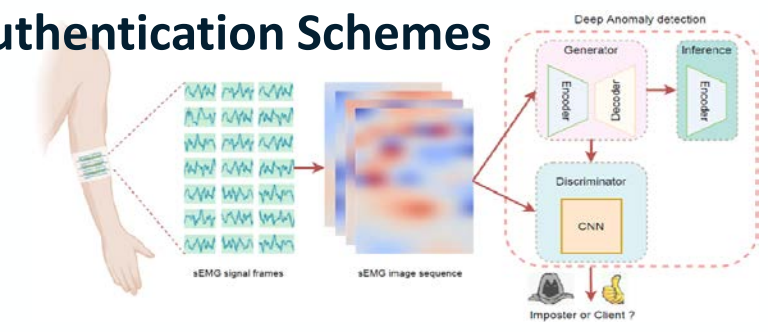



# New Mexico EPSCoR SMART Grid Center: Sustainable, Modular, Adaptive, Resilient, Transactive

- Motivation:** High penetration of renewable energy sources, coupled with emerging storage deployments and electrification of transportation, lead to new patterns and challenges in balancing of generation and demand. Electric grid (both transmission and distribution) need to keep evolving to provide flexible access to both resources and assets on the grid.
- Objective:** Our goal is to create a comprehensive framework for distribution feeders to evolve into managed microgrids. We will address key questions such as:
  - 1) What generation and storage resources should be deployed, and where should they be sited, based on local generation and demand patterns?
  - 2) How should distribution topology and sectionalizing be organized to enable reconfiguration and resilience?
  - 3) How to develop local energy markets?, i.e. how can transmission and distribution system operators source grid flexibility services directly from end users, including residential customers?
  - 4) What tariff designs could be used to engage and benefit participants (both producers and consumers) ?
  - 5) How to ensure traditional reliability, resiliency and quality of service of the electric grid given new grid services model ?
  - 6) What services are considered critical, and how can these services be guaranteed?
  - 7) How do we develop adequate protection schemes for the new grid with high renewables penetration?
  - 8) What are the additional sensing needs for the new SMART grids and what new types of sensors are needed ?
  - 9) How can we source Restoration and Black start services from distribution feeders?

The Distribution Feeder Microgrid (DFM) is a SMART evolution of conventional feeder design

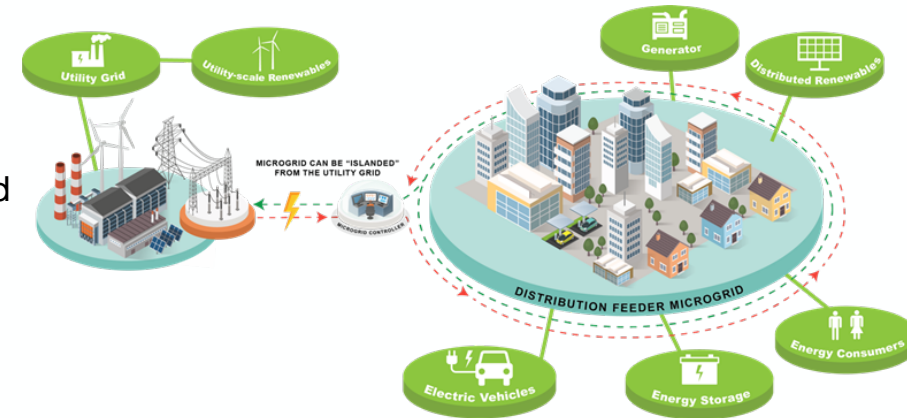

Secure  
Modular  
Adaptive  
Resilient  
Transactive

# In conclusion : Microgrids are flexible and efficient new resource

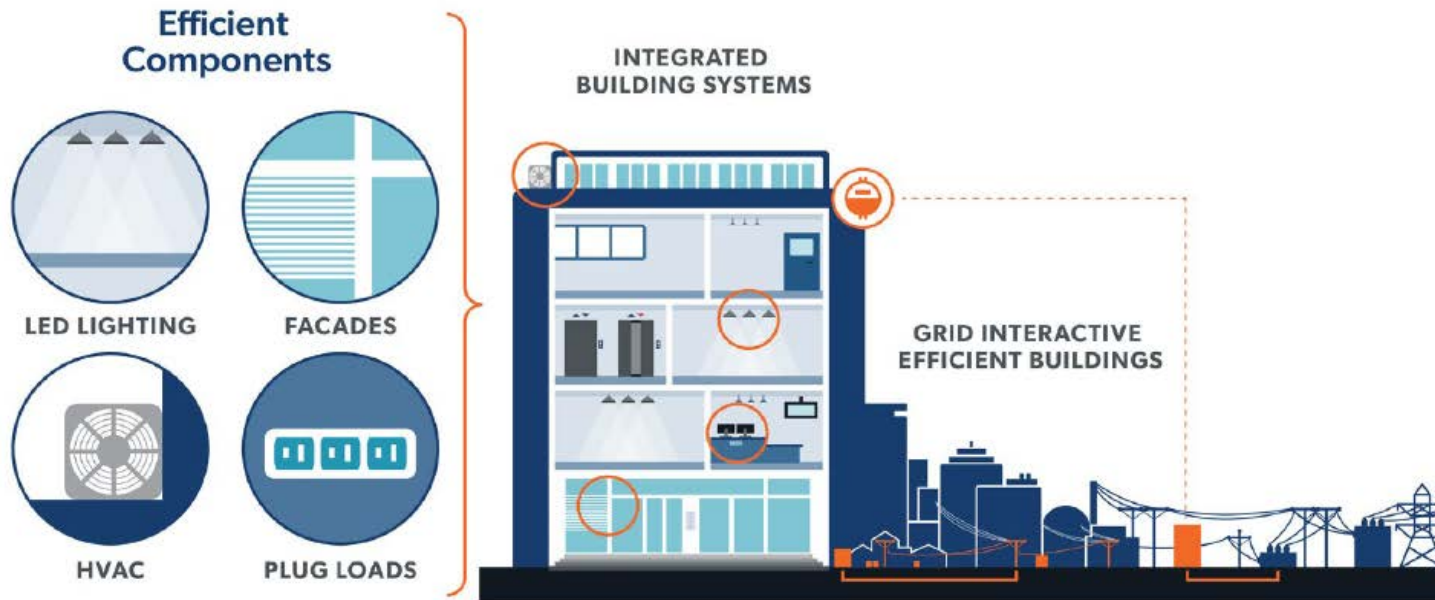

*Illustration of a commercial Grid Efficient Building ( GEB ), or, for residential HAN), efficient components and communications  
[Ref: Satchwell, Andrew, Mary Ann Piette, Aditya Khandekar, Jessica Granderson, Natalie Mims Frick, Ryan Hledik, Ahmad Faruqui et al. "A National Roadmap for Grid-Interactive Efficient Buildings." (2021).]*