

ELECTRIFICATION OF TRANSPORTATION: WORKFORCE EDUCATION AND HIGH TECH OPPORTUNITIES FOR NEW MEXICO

Presented to the
New Mexico Transportation Infrastructure Revenue Subcommittee
September 29th 2023

Dr. Olga Lavrova

Klipsch School of Electrical and Computer
Engineering

Electric Utility Management Program



BE BOLD. Shape the Future.

Motivation

- The United States has a long-term goal to decarbonize the electric grid¹. This will require several market transformations across multiple sectors, including renewable power generation and storage options, increased electrification of end-use energy consumption, including substantial increase in electrification of transportation and machinery.
- Electrification of multiple sectors (residential, commercial, industrial, transportation, etc) will require ubiquitous applications of power electronics of various ratings

[1] The White House. 2021. "President Biden Signs Executive Order Catalyzing America's Clean Energy Economy Through Federal Sustainability." <https://www.whitehouse.gov/briefing-room/statements-releases/2021/12/08/fact-sheet-president-biden-signs-executive-order-catalyzing-americas-clean-energy-economy-through-federal-sustainability/>

Yesterday's Power System ... One Way Power Flow

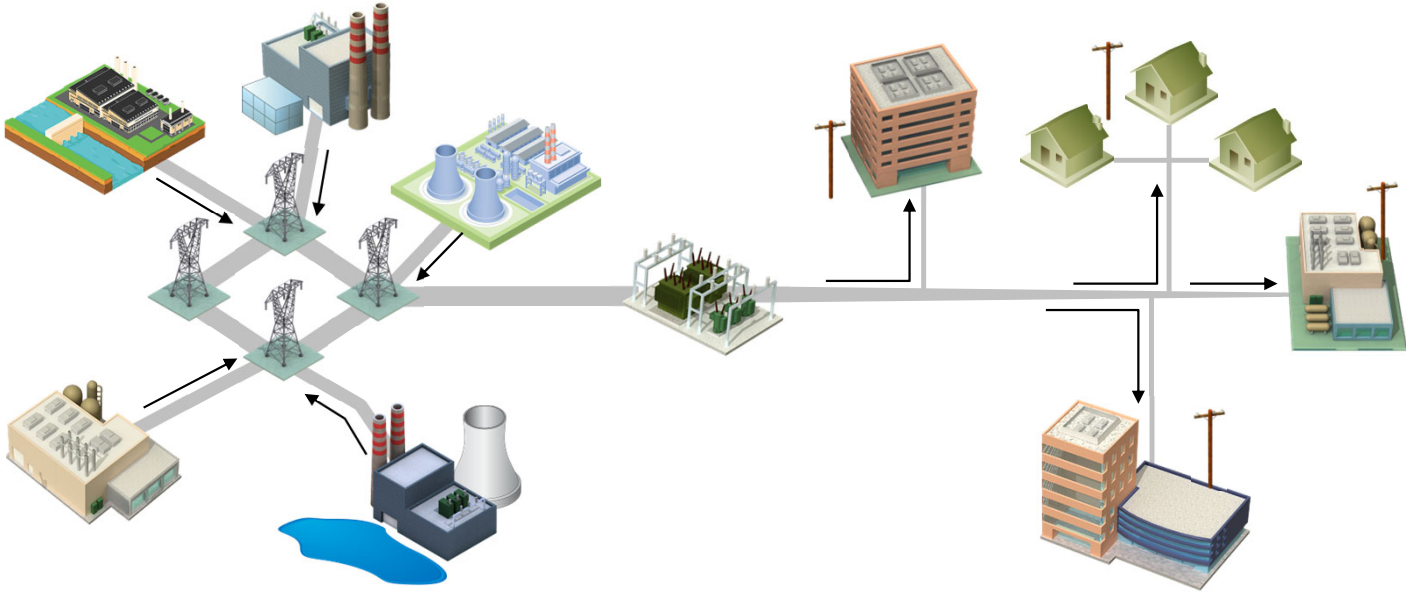

Generation-Transmission

Substation

Distribution System

Today's Power System ... Two Way Power and Information Flow

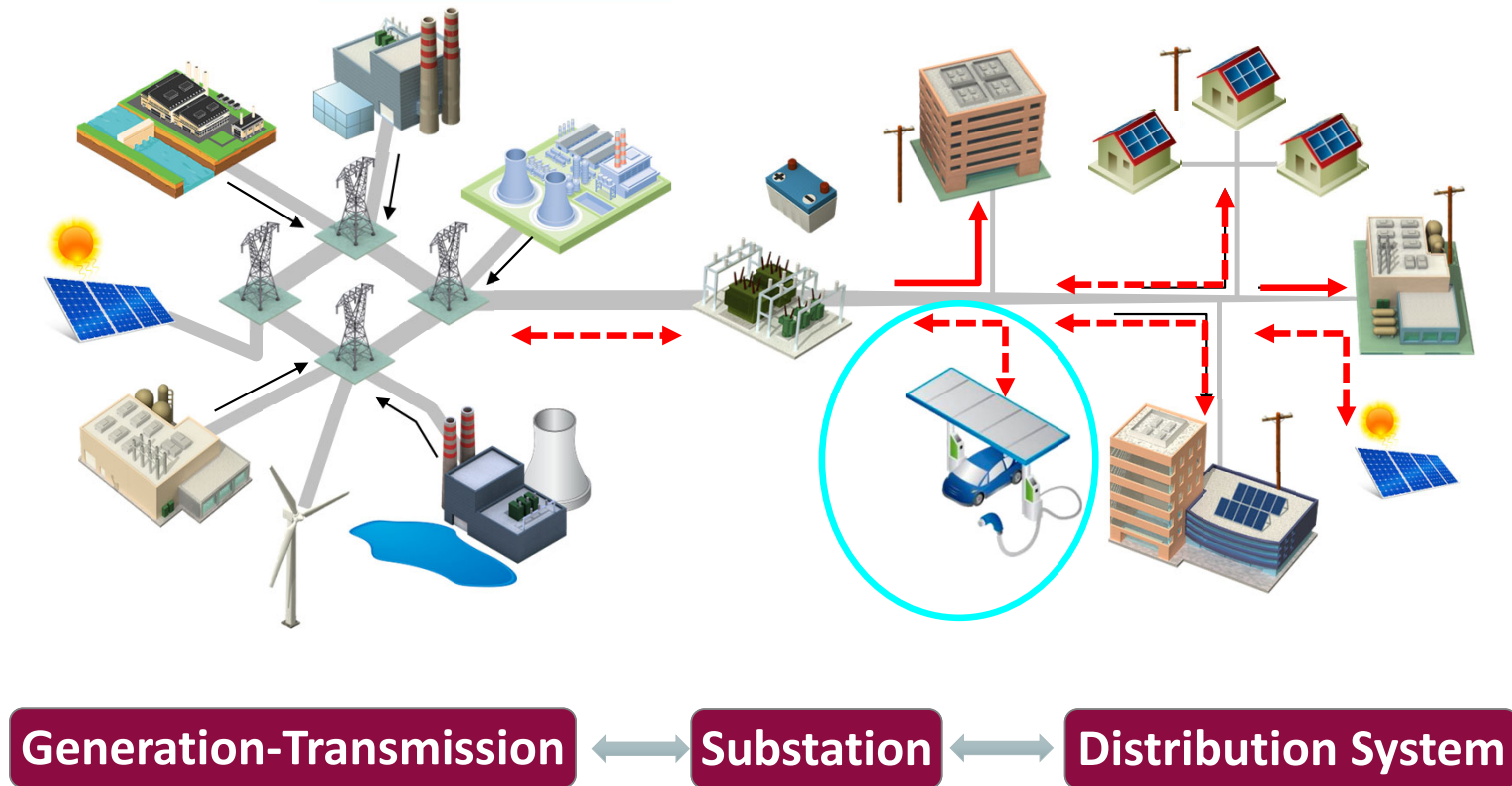

Where are changes: System-Wide Application Space

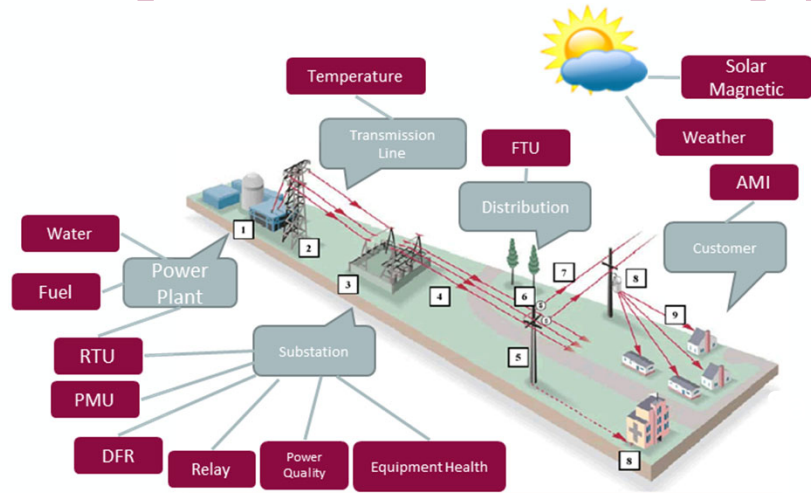

Modified from Duke Energy

<https://www.progress-energy.com/florida/home/safety-information/storm-safety-tips/restoration.page?>

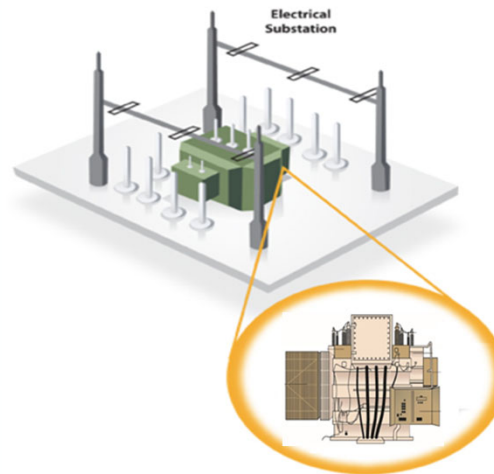

Miele showcases a washing machine that knows when electricity is cheap

By Bridget Borgobello
12:16 September 1, 2010

2 Comments
9 Pictures

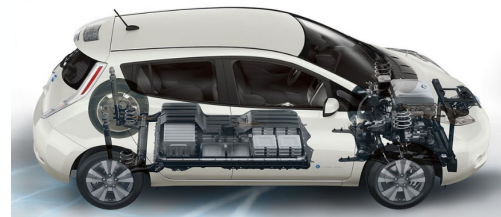
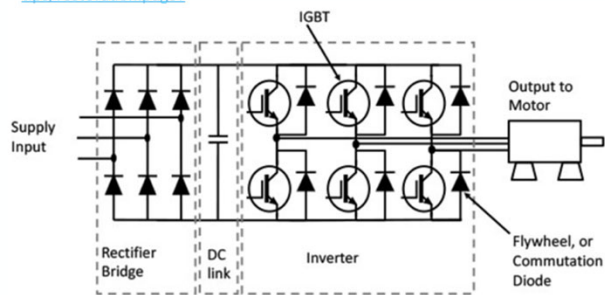

BE BOLD. Shape the Future.

Slide number 5

Walking the Talk...

...or Driving the Talk...

- 12 years of maintenance-costs-free EV ownership...
- The vehicle paid for itself in ~ 7 years



What are the questions that hinder EV adoption ?

❑ Upfront cost

- Cost of the vehicle
- Cost of charging infrastructure
- Cost of electricity: will EV ownership increase my electric bill too much?
- ❖ Solution: Customer access to information:
[see for example T. Solomon's presentation: "Electric 'fuel' is like gas at \$0.75 / gal "]

❑ Range Anxiety and Perception of Lack of Infrastructure

- ❖ Solution: Broad charging network (already underway via the Bipartisan Infrastructure Bill)

❑ Can the US Electric Grid handle EV charging

- ❖ Solution: Yes, it can, through a variety of hardware and policy solutions
(for example, night time charging tariff for EVs, already implemented)

❑ Are EV's really green and sustainable ?

- ❖ Solution: Yes, if you look at the cradle-to-the-grave analysis and sustainability metrics
(including even mineral resources, etc, etc)

Electric Grid Capacity, Planning and Research Questions:

- NMSU's education curriculum and research in advanced energy topics answers exactly these type of questions, and disseminates the information to the public:

- how is the energy transition happening ?
- can we (consumers) handle it ?
- can the grid handle it ?
- How do we prepare the workforce development for the new jobs?
- etc, etc



Electrification of transportation: not only passenger vehicles

	CLASS 1 6,000 lb & less		CLASS 5 16,001 to 19,500 lb
	CLASS 2 6,001 to 10,000 lb		CLASS 6 19,501 to 26,000 lb
	CLASS 3 10,001 to 14,000 lb		CLASS 7 26,001 to 33,000 lb
	CLASS 4 14,001 to 16,000 lb		CLASS 8 33,001 lb & over

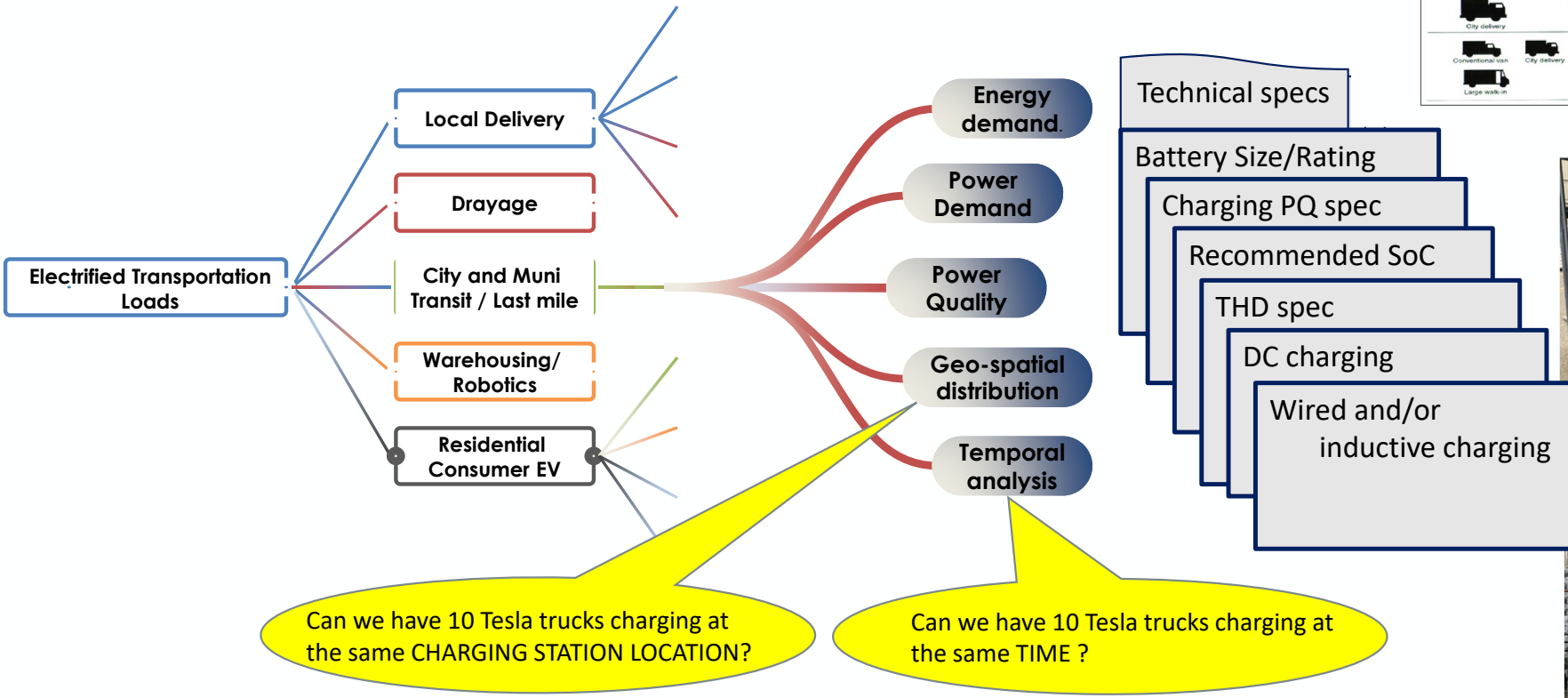

Charging infrastructure is not boring !

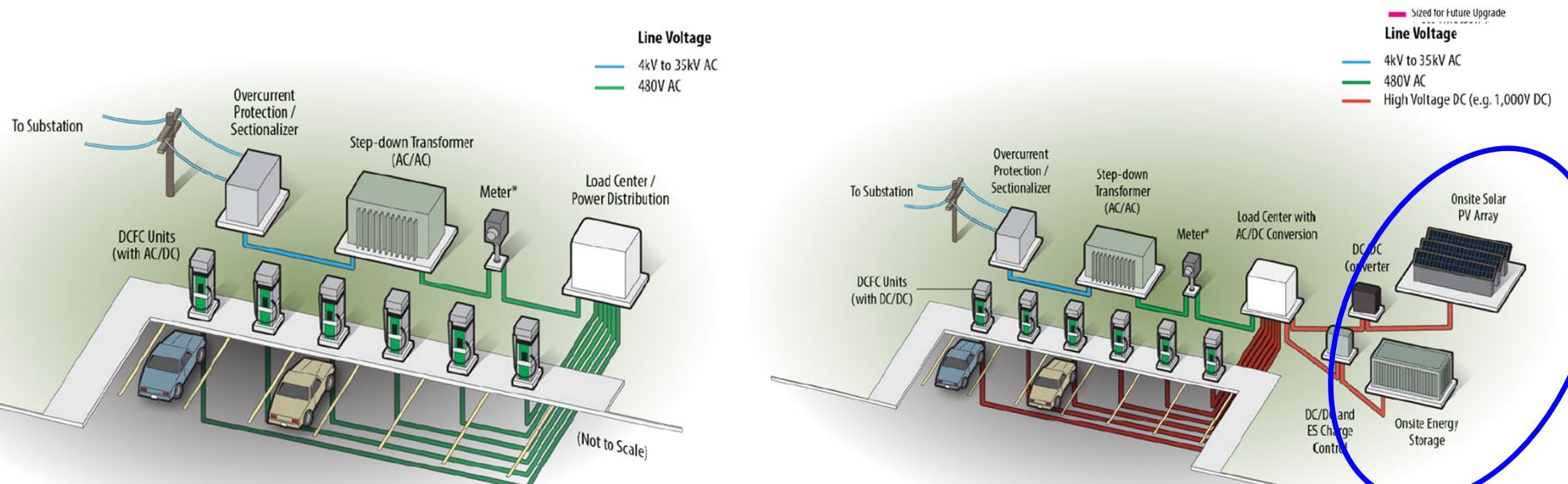

- Advanced designs demonstrate potential for multiple benefits:
 - Multi-type use (passenger and long haul commercial trucks)
 - Energy efficiency and smart utilization
 - Multiple revenue streams for charging station owners /operators – including payments for grid services

“Considerations for Corridor and Community DC Fast Charging Complex System Design”, INL publication

What are the opportunities for NM?

- Jobs ! Jobs ! Jobs!
- Meeting ETA requirements
- Better quality of life for consumers through reduction of costs of ownership and reduction in pollution levels (cleaner air)

- These are all well paying jobs

...and NMSU has degrees and programs for all of these areas

What types of employment/ job sectors needed?

- High Tech Construction
- Electrical Engineering - design, maintenance
- CAD drafting, records maintenance, electrical and fire safety compliance
- Planning and Policy
- Customer Service, Field Service (including EV charging station support, troubleshooting and maintenance)
- Markets, Economics, Insurance
- Communications and Broadband Networking
- Cybersecurity, Computer Science

Electrical Engineering education curriculum for new transportation modalities

EE 432/537 Power Electronics

- Our “Power Electronics” class teaches modern power electronics technologies as applicable to EV, Renewables, transportation (aviation, trains), etc.

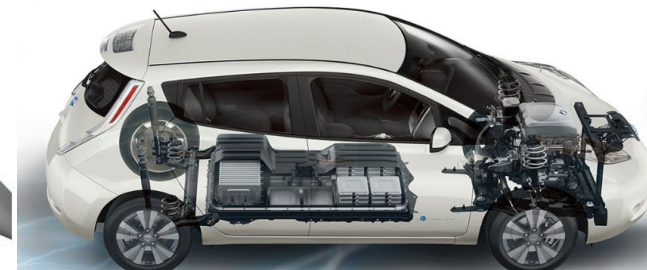
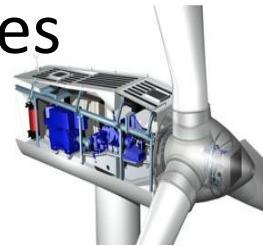

- we first take an academic approach to learn about all the components in EVs
- then, in the upcoming semester, we will be taking an actual EV apart (safely!) to gain hands-on knowledge

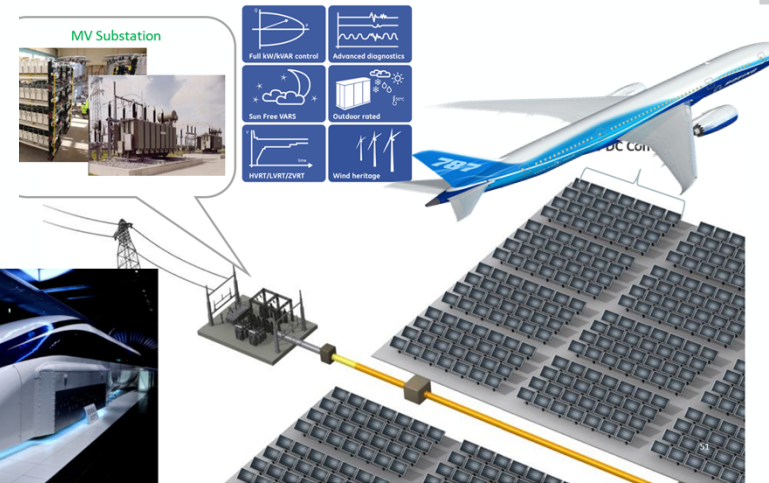

Is cybersecurity important for electrified transportation?

We've got a degree for that...

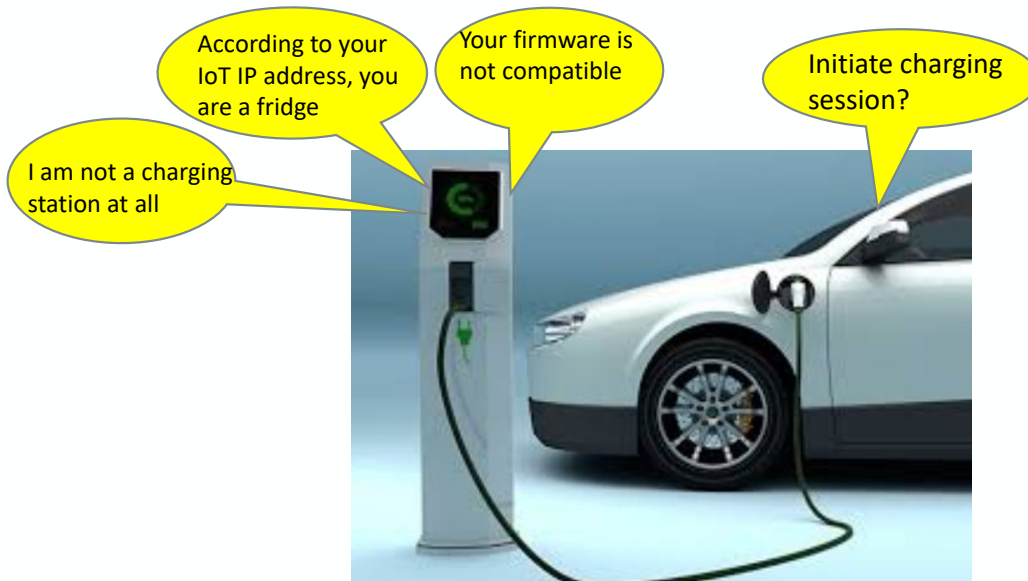

PS: This is only an illustration, not meant to scare anyone away from using public charging infrastructure. Typical cyber hygiene must always apply

B.S. in Cybersecurity Degree



BE BOLD. Shape the Future. | New Mexico State University | www.cs.nmsu.edu

Program Starts Fall 2020

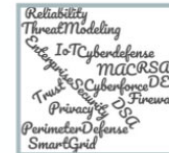

Why do a Bachelor's Degree in Cybersecurity?

- By 2021, it is estimated that there will be 6 million cybersecurity positions worldwide
- 28% cyber-security job growth through 2026, compared to national job growth rate will be 7%
- Cybersecurity is a multi-faceted and complex discipline, requiring formal education programs.
- 200,000 cybersecurity positions available nationally; increasing number of openings.
- Jobs include Cybersecurity Analyst; Security Architect; Cyber defense Expert; Cyber Vulnerability Analyst.



Degree Program Goal and Courses

Goal:

Produce competent graduates to secure regional, national and global cyberspace. Build a professionally trained cybersecurity workforce for industry, national laboratories, government, and academia.



Illustrative Courses:

Management of Information Security; Computer Science Principles; Introduction to Data Structures; Introduction to Cryptography; Operating Systems I; Computer Security; Computer Networks I; Introduction to Security Technology and Loss Prevention; Hardware Security and Trust; Introduction to Digital Forensics and Incident Response; Cloud and Edge Computing.

Contact:

Professor Jay Misra
Director,
BS Cybersecurity Program
Email: misra@nmsu.edu

CS Office
Niki Davis
Email: nadrew@nmsu.edu



BE BOLD. Shape the Future.

Slide number 13

NMSU's Public Policy Degrees:

Economics (Public Policy) - Master of Arts

Candidates for the Master of Arts in economics must successfully complete a minimum of 30 graduate credits (concentrations may require more than 30 graduate credits). At least 12 credits beyond the core courses (**AEEC 501** Microeconomic Theory, **AEEC 502** Macroeconomic Theory, **AEEC 540** Econometrics I) must be earned by taking courses taught by economics faculty members in the Department of Economics, Applied Statistics and International Business. At least two of the three core courses must be completed at NMSU. Twenty-one of the credits must have one of the four following prefixes: AEEC, ECON, ECDV, or AG E. At least twenty-four of the credits must be associated with courses numbered 500 or above. All students must meet the requirements specified in the general regulations and requirements for admission to the Graduate School and to candidacy. Students preparing to enter the program are encouraged to complete the following:

1. one course in intermediate microeconomic theory and one course in macroeconomic theory with minimum grades of B;
2. one course in college-level calculus; and
3. one course in statistics, including simple regression.

Those students not having completed these courses may be admitted with the requirement that the deficiencies be completed at the beginning of the graduate program. Those students interested in the concentration in regulatory economics are advised to complete two courses in college-level statistics.

<https://deptofgov.nmsu.edu/academic-programs/ba-in-government.html>

<https://deptofgov.nmsu.edu/academic-programs/mpa.html>



MPA: NASPAA-accredited, focuses on public service leadership, and promotes real world application.

Economics BA: Flexible, ideal for graduate pursuits, and offers a comprehensive curriculum.

Ongoing research topics: Can the grid handle it?

- We perform multiple system studies for multiple scenarios to analyze best and worst case for different load growth (growth in number of EVs) scenarios.

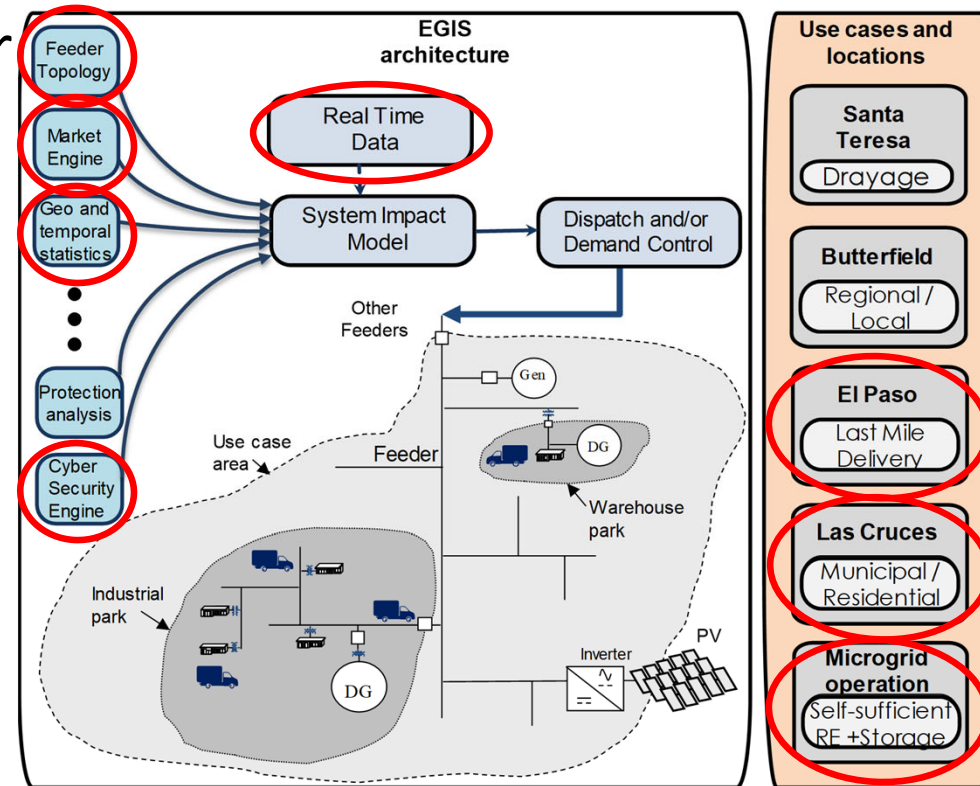
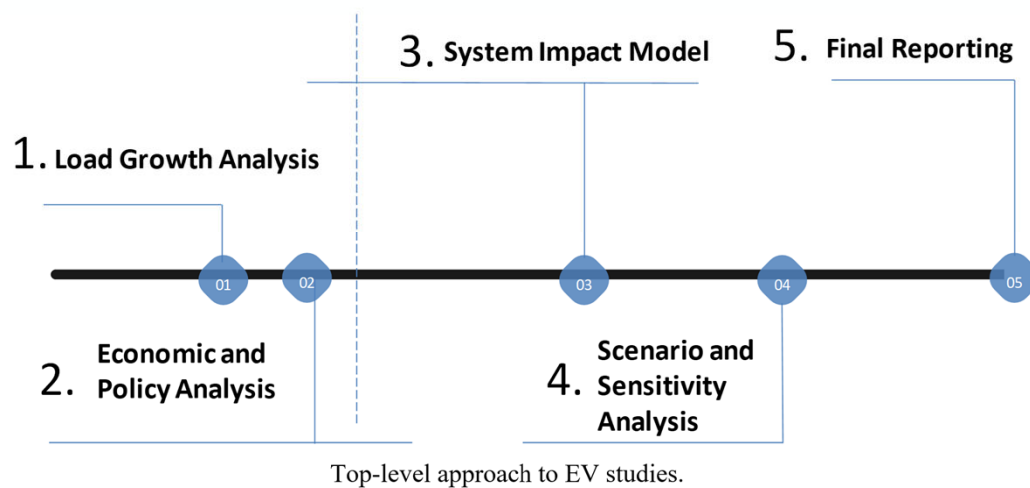

Ongoing research topics: What type of upgrades may be needed and when?

NMSU's Power group and Electric Utility Management Program provided analysis of hosting capacity for PNM electric distribution electric circuits – as per the request from PRC.

modeling results of Tramway 11. A well-developed residential area, Tramway 11 services 1888 residential customers and has a total of 75.04 circuit miles.

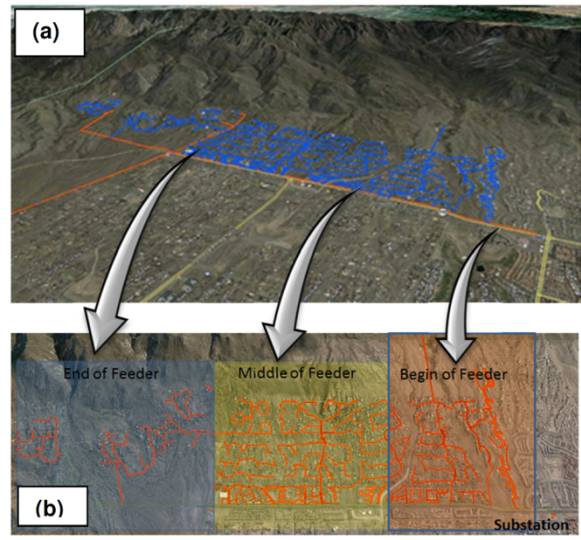
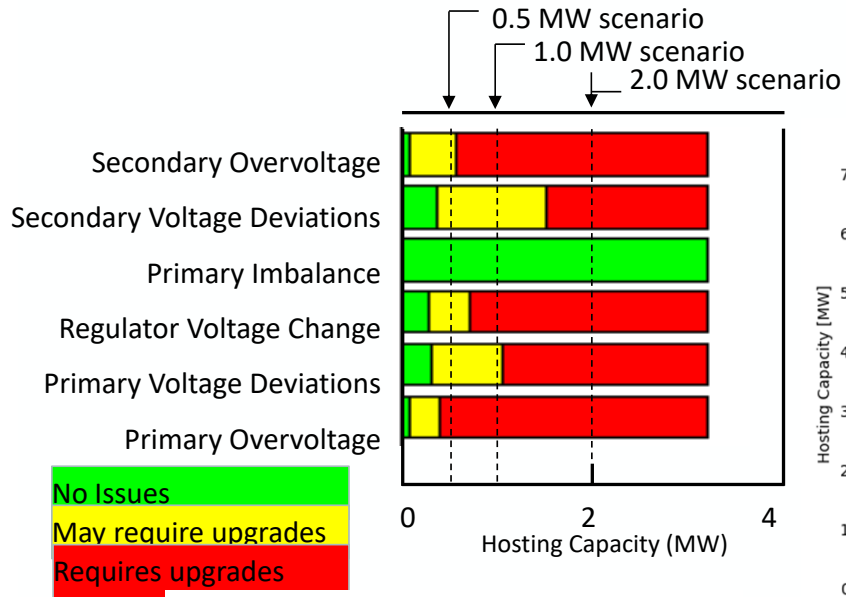
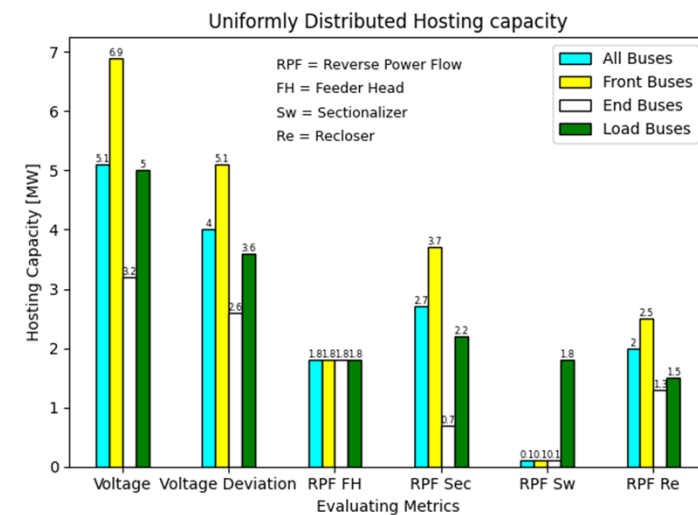

Figure 3. (a) Google™ image of Tramway 11 with feeder overlay, (b) 1D projection of the feeder, showing designations of Beginning, Middle and End of the feeder



No Issues
May require upgrades
Requires upgrades

Research Details found here:
[Distributed Photovoltaic Feeder Analysis: Preliminary Findings from Hosting Capacity Analysis of 18 Distribution Feeders](#). EPRI, Palo Alto, CA: 2013. 3002001245.



Future Research Questions:

□ EV Battery 2nd life Applications

- Multiple potential areas exist
- Grid Services have a huge potential for both extension of the service life of the batteries (therefore not needing to recycle till much later) AND for additional income streams for yet a different sector of industry/jobs.

□ EV Battery Recycling

- Multiple pilots exist. Technologically challenging (but in a good way) research

This company is earning money with second-life Nissan LEAF batteries

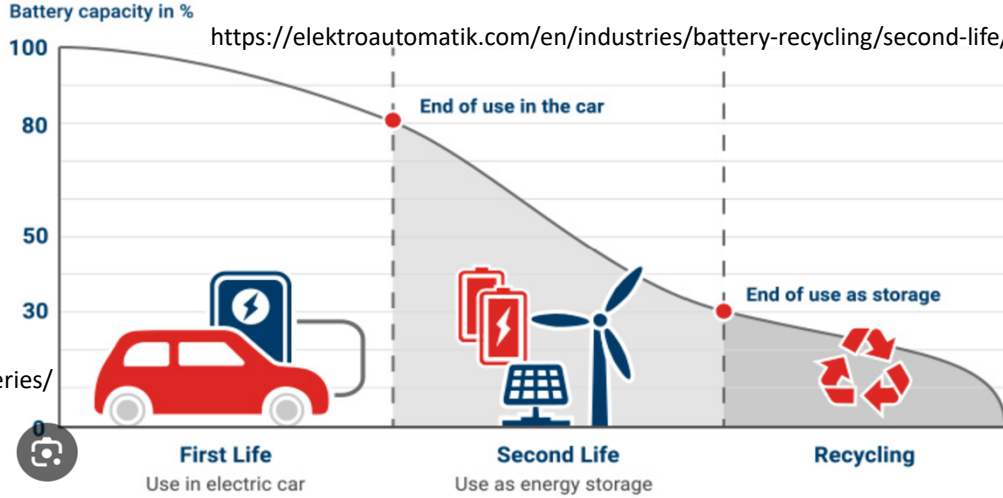

<https://chargedevs.com/newswire/this-company-is-earning-money-with-second-life-nissan-leaf-batteries/>



BE BOLD. Shape the Future.

Sl



Future Research Questions:

- Bi-Directional / V2X: Exploring and enabling bi-directional services from vehicles for V2X (Vehicle-to-Home V2H, Vehicle-to-Building (V2B) and Vehicle-to-Grid (V2G))
 - Energy services to dedicated/selected buildings as means of managing customer/building electric energy costs
 - Additional revenue streams for selling energy to the grid
 - Think of this as similar to “short term rental “ of your vehicle’s battery by the grid: for several minutes a day, you may allow the electric utility to use your vehicle’s battery in an exchange for monetary compensation.
- Emergency power and energy delivery services
 - A fleet of EVs with substantial battery capacity can serve as a mobile emergency “power station” in cases of outages or other public emergencies, providing life saving measures

Features	“Dumb Charging”	Smart Charging	V1G	Bidirectional Charging V2B V2H	V2G NUVVE
One-way EV charging	⚡	⚡	⚡	⚡	⚡
Set time of charge		⚡	⚡	⚡	⚡
Set charge rate			⚡	⚡	⚡
Access energy markets			⚡	⚡	⚡
Store + discharge energy				⚡	⚡
Combine energy from multiple EVs (create a VPP)					⚡
Perform grid services and sell energy back to grid*					⚡

<https://nuvve.com/faq-items/what-is-the-difference-between-smart-charging-v1g-v2b-and-v2g/>

Texas man uses new 2021 Ford F-150 to heat home, power appliances during blackout



<https://www.freep.com/story/money/cars/ford/2021/02/18/texas-power-outage-storm-blackout-ford-f-150-generator/6797103002/>

Future Research Questions:

- ❑ Extreme Fast Charging (xFC) Systems Integration (350 kW -> 600kW):
- ❑ Liquid Cooled Charging
 - Both technologies reduced the charging time to be comparable to regular gas filling up time

- ❑ Wireless Charging and Transportation Systems:



https://www.youtube.com/watch?v=oVEuOtRLNzc&ab_channel=TechVision



WEST LAFAYETTE, Ind. — Purdue University engineers have invented a new, patent-pending charging station cable that would fully recharge certain electric vehicles in under five minutes – about the same amount of time it takes to fill up a gas tank.

<https://www.purdue.edu/newsroom/releases/2021/Q4/electric-vehicles-could-fully-recharge-in-under-5-minutes-with-new-charging-station-cable-design.html>

'World's first wireless-charging pavement' for electric cars finished with phase 1 in Indiana



Where are we conducting this research?

IDEAL: Testbed for Clean Energy and Grid Modernization

A state-of-the-art testbed for cutting edge research to improve the efficiency of the nationwide energy distribution system, to integrate more renewable energy projects and electrification of transportation and to improve conditions for the resiliency improvement through proliferation of microgrids.

IDEAL: Integrated Digital Enterprise Accelerator Lab

The micro-grid at IDEAL center is a three phase, 4kV feeder and a DC link, interconnecting buildings containing PV interfaced with smart inverters, controllable loads, electric storage and cybersecurity equipment. IDEAL provides the platform for cutting edge research in the areas of grid modernization, renewable energies, electric vehicles and power electronics, as well as sustainable and secure energy economy.

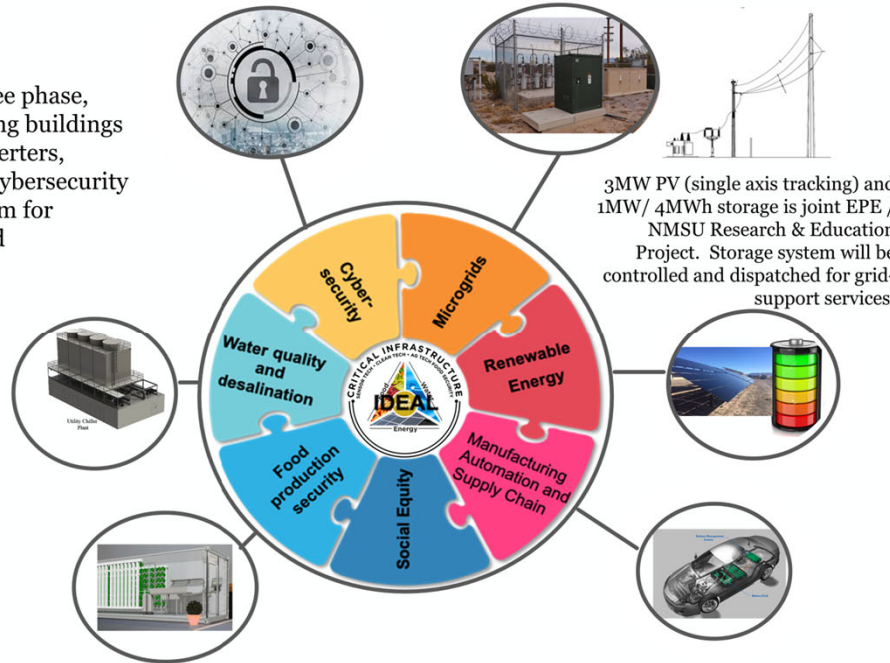
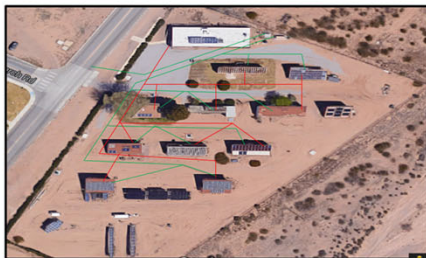

Senators Ben Ray Lujan and Heinrich secured \$1.6M for IDEAL upgrades into a microgrid test lab



In conclusion

- New Mexico has a significant potential for electrification of broad range of industrial and residential sectors, including transportation.
- Economic, societal and technological benefits will contribute to energy equality and can specifically benefit LMI and underserved populations;
- Electrification of transportation is MUCH MORE than only personal passenger vehicles, we have to plan for industrial and commercial transport
- Electrification of residential and industrial transportation will accelerate achievement of the New Mexico's Energy Transition Act goals and can lead to creation of permanent well-paid jobs in NM.
- NMSU, other universities and community colleges are already providing education and training in these areas.

THANK YOU
for your attention!

